



032

**COMANDO E SEGNALAZIONE
FILO PANNELLO SM2 Ø30**

**COMMAND AND SIGNALLING
FLUSH-MOUNT SM2 Ø30**

032



SISTEMA MODULARE 30

MODULAR SYSTEM 30

LA SERIE 032

La serie 032 "SISTEMA MODULARE 30" è progettata per un utilizzo sicuro, facile e intuitivo; le soluzioni adottate facilitano la realizzazione di varie combinazioni garantendo risparmio di tempo e risorse. Il corpo in alluminio anodizzato permette il montaggio a filo pannello, donando eleganza e funzionalità al quadro di comando.

Le operazioni di montaggio e manutenzione possono essere svolte con normali utensili e con estrema accessibilità agli operatori.

LA STRUTTURA

Tutti gli operatori possono essere fissati con ghiera metalliche. L'accoppiamento plastica / metallo garantisce serraggi sicuri e permanenti. L'ancoraggio tra operatori ed elementi di contatto o elementi portalampada, è costruito con un profondo incasso poi trattenuto con una molla in acciaio inox.

La struttura degli elementi di contatto è realizzata con estrema robustezza e flessibilità. La componibilità del sistema permette di comporre gli elementi retro pannello in molteplici configurazioni.

La dimensionatura dei blocchi e le sezioni dei sistemi di serraggio garantiscono notevole resistenza alle tensioni da strappo. I contatti degli operatori New Elfin sono caratterizzati dalle grandi dimensioni delle superfici di contatto e dalla particolare conformazione che garantisce performance di efficienza operativa e di durata superiori alla media. I nostri prodotti sono progettati e costruiti con tecnopolimeri Hi-tech. Gli spessori applicati e l'aggiunta di materiale di rinforzo conferiscono a tutte le parti grande robustezza e resistenza.

Le parti metalliche interne sono in acciaio inox o in acciaio trattato, mentre le guarnizioni in gomma resistono a tutte le condizioni climatiche.

DISPOSITIVI D'EMERGENZA

Tutti i sistemi di comando possono essere dotati di un esclusivo dispositivo di arresto d'emergenza, che difende i segnali di arresto di emergenza, mantenendoli coerenti ai requisiti per i quali sono stati progettati.

Il dispositivo neutralizza fattori esterni non controllabili quali forti shock, corrosioni, errori di utilizzo, inadeguata manutenzione ecc.

THE 032 SERIES

The 032 "MODULAR SYSTEM 30" series is designed for a safe, easy, intuitive use; the solutions adopted facilitate the execution of a range of combinations guaranteeing time and resources saving.

Assembly and maintenance can be performed by using standard tools and with easy access to the operators.

The body in anodized aluminum allows a flush mountig, giving elegance and functionality to the control panel

STRUCTURE

All operators can be secured by metal locking rings .

The plastic / metal combination guarantee secure and permanent tightening.

The anchoring mechanism between operators and contact blocks or lampholders consists of a deep recess and a stainless steel spring holding the operator in place.

The structure of the contact blocks is extremely sturdy and flexible.

The modular system allows to compose the rear panel elements in multiple configurations.

The block size and the sections of the tightening systems guarantee considerable tear resistance.

The New Elfin operator contacts feature a large-sized contact surface and a special shape which guarantee above-average efficiency and life.

Our products are designed and manufactured using Hi-tech technopolymers.

The thickness applied and the addition of reinforcement material give all parts great sturdiness and resistance.

The internal metallic parts are in stainless or treated steel, while the rubber gaskets are resistant to all climatic conditions.

EMERGENCY DEVICES

All command systems can be equipped with an exclusive emergency stop device, which protects the emergency stop signals, keeping them coherent to the design requirements.

The device neutralizes external uncontrollable factors, such as strong shocks, corrosion, incorrect use, unsuitable maintenance, etc.

SISTEMA MODULARE 30 MODULAR SYSTEM 30

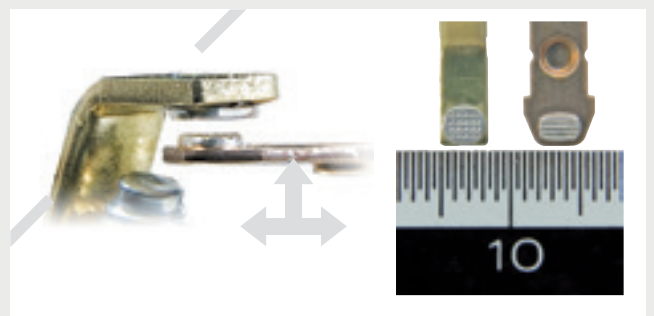
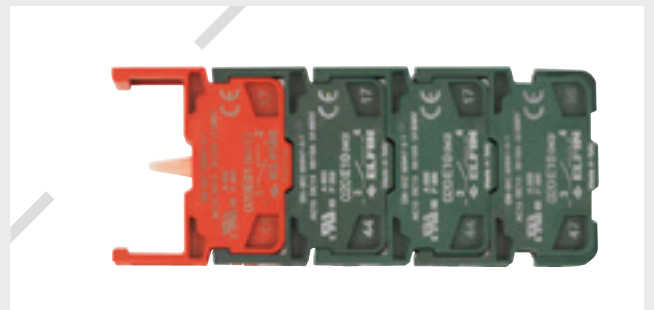
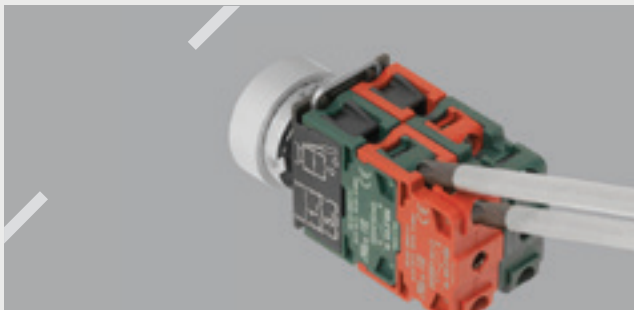
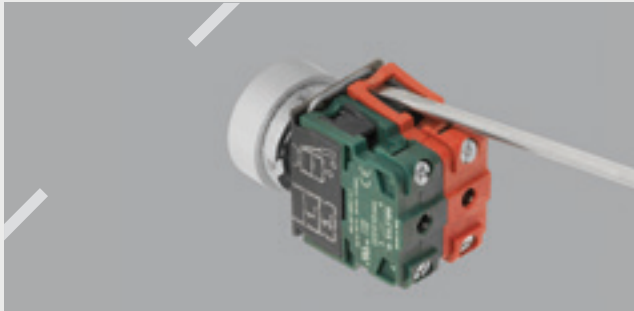
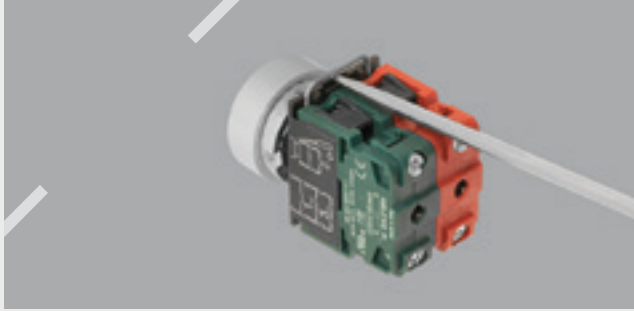

Caratteristiche tecniche

Technical data

Caratteristiche generali

Rispondenza alle norme	EN/IEC 60947-1, EN/IEC 60947-5-1, EN/IEC-5-4, EN/IEC 60947-5-5, EN/ISO 13850, EN/IEC 60204-1, IEC 60364-5-53, UL 508, CSA C22-2 N° 14, EN45545-2, EN61373, EN60077-2
Omologazioni	UL, CSA, EAC
Protezioni climatiche	In esecuzione normale T.C. tutti i climi (40° - UR35%)
Limiti di temperatura	Funzionamento : ≥ -25 °C ÷ ≤ +65 °C Stoccaggio -35 °C +70 °C
Posizione di funzionamento	← → ↑ ↓
Protezione contro scossa elettrica	Classe II secondo IEC 61140
Altitudine d'impiego	≤ 3.000 m
Grado di protezione	IP65 pulsanti normali, luminosi, lampade, selettori.
Dimensioni di montaggio	Pannelli con spessore 1-6 mm Foratura secondo EN/IEC 60947-5-1

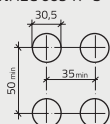

Caratteristiche meccaniche

Resistenza agli urti	50g (durata: 11ms) mezza sinusoide secondo IEC 60068-2-7												
Resistenza alle vibrazioni	16g 40-500 Hz secondo IEC 60068-2-6												
Coppia di serraggio	Ghiera di fissaggio operatori: 3-3,5 Nm, Viti terminali: 0,8-1,0 Nm												
Viti terminali	Testa combinata taglio e Phillips Ph2 in acciaio zincato o acciaio inox per versioni E10AU/E01AU Capacità di chiusura : ≥ 1 x 0,5 mm / ≤ 2x2,5 mm Capicorda a forcina "spring spade"												
Forze di azionamento	Pulsante con contatto NO: 5N - selettore: 0,15 Nm contatti aggiuntivi NO /NC: 1,5 N												
Funzionamento contatti	NO/NC ad azione lenta con autopulitura a strisciamento- Contatti NC ad apertura positiva ⊕ secondo EN/EIC947-5-1 allegato K												
Corsa e commutazioni contatti	<table border="1"> <tr> <td>1mm</td> <td>NC</td> <td>Normalmente Chiuso</td> </tr> <tr> <td>3,6mm</td> <td>NO</td> <td>Normalmente Aperto</td> </tr> <tr> <td>2,5mm</td> <td>NCR</td> <td></td> </tr> <tr> <td>1,9mm</td> <td>NOA</td> <td></td> </tr> </table>	1mm	NC	Normalmente Chiuso	3,6mm	NO	Normalmente Aperto	2,5mm	NCR		1,9mm	NOA	
1mm	NC	Normalmente Chiuso											
3,6mm	NO	Normalmente Aperto											
2,5mm	NCR												
1,9mm	NOA												
Forza di apertura positiva	Pulsante normale: 5 N Pulsante a fungo: 40 N												
Velocità di azionamento portalampada	Min. 10 mm / sec Max. 20mm / sec												
Durata meccanica	Pulsanti normali, luminosi: 3 milioni di manovre. Selettori, manipolatori: 1 milione di manovre. Emergenza fungo aggancio e stabili: 500.000 manovre												
Grado di protezione	Morsetti IP20 secondo IEC60529												
Identificazione morsetti	1° cifra: ordine di montaggio su flangia di connessione - 2° cifra: funzione contatto su elemento 1-2 NC / 3 4 NO												

General features

Standards compliance	EN/IEC 60947-1, EN/IEC 60947-5-1, EN/IEC-5-4, EN/IEC 60947-5-5, EN/ISO 13850, EN/IEC 60204-1, IEC 60364-5-53, UL 508, CSA C22-2 N° 14, EN45545-2, EN61373, EN60077-2
Approvals	UL, CSA, EAC
Climatic protection	Normal operation for all climates (40° - RH35%)
Temperature ranges	Operating: ≥ -25 °C ÷ ≤ +65 °C Storage -35 °C +70 °C
Operating positions	← → ↑ ↓
Electrical shock protection	Class II in compliance with IEC 61140
Operating altitude	≤ 3.000 m
Protection degree	IP65 normal, illuminated push buttons lamps, selector switches .
Mounting dimensions	1-6 mm panels. Drilling in compliance with EN/IEC 60947-5-1

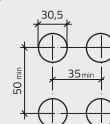

Mechanical features

Shock resistance	50g (duration:11ms) half sine wave in compliance with IEC 60068-2-7												
Vibration resistance	16g 40-500 Hz in compliance with IEC 60068-2-6												
Tightening torque	Operator locking ring: 3-3.5 Nm. Terminal screws: 0.8-1.0 Nm												
Terminal screws	Combined slot and Phillips Ph2 head, zinc plated or stainless steel for E10AU /E01AU. Connection capacity : ≥ 1 x 0.5 mm / ≤ 2x2.5 mm Fork spring spade terminals												
Operating forces	Push-button with NO contact: 5N - selector switch: 0.15 Nm, additional NO/NC contacts: 1.5 N												
Contact operation	NO/NC slow action with wiping, self-cleaning, NC contacts, positive opening ⊕ in compliance with EN/EIC947-5-1, annex K												
Contact travel and switching points	<table border="1"> <tr> <td>1mm</td> <td>NC</td> <td>Normally Closed</td> </tr> <tr> <td>3,6mm</td> <td>NO</td> <td>Normally Open</td> </tr> <tr> <td>2,5mm</td> <td>NCR</td> <td></td> </tr> <tr> <td>1,9mm</td> <td>NOA</td> <td></td> </tr> </table>	1mm	NC	Normally Closed	3,6mm	NO	Normally Open	2,5mm	NCR		1,9mm	NOA	
1mm	NC	Normally Closed											
3,6mm	NO	Normally Open											
2,5mm	NCR												
1,9mm	NOA												
Positive opening force	Normal push-button: 5 N Mushroom push-button: 40 N												
Operating speed lampholder	Min. 10 mm / sec Max. 20mm / sec												
Mechanical life	Normal, illuminated push-buttons: 3 million cycles. Selector switches, joysticks: 1 million cycles. Emergency stop mushroom push-buttons, latching or maintained: 500.000 cycles												
Degree of protection	Terminals IP20 in compliance with IEC60529												
Identification of terminals	1 st digit: assembling order on connection flange 2 nd digit: element contact function 1-2 NC / 3-4 NO												



Caratteristiche tecniche

Technical data

Caratteristiche elettriche

Tensione nominale isolamento	Ui 690 V grado di inquinamento 3 secondo EN/IEC 60947-1																																												
Tensione di tenuta agli impulsi	Uimp 4kV secondo EN/IEC 60947-1																																												
Corrente nominale termica	Ith10A secondo EN/IEC 60947-5-1																																												
Protezione corto circuito	Fusibili DIAZED 10A classe d'intervento gL/gG forma D II secondo IEC 60269-1																																												
Materiale contatti	Pastiglie di contatto in Ag 1000/1000 per versioni Au: Ag 1000/1000, dorati																																												
Categorie nominali d'impiego	Secondo EN/IEC 947-5-1 <table border="1"> <thead> <tr> <th colspan="2">Cat.AC15</th> <th colspan="2">Cat.DC13</th> </tr> <tr> <th>Ue V</th> <th>Ie A</th> <th>Ue V</th> <th>Ie A</th> </tr> </thead> <tbody> <tr> <td>24</td> <td>10</td> <td>24</td> <td>5</td> </tr> <tr> <td>48</td> <td>8</td> <td>48</td> <td>2,7</td> </tr> <tr> <td>60</td> <td>6</td> <td>60</td> <td>2</td> </tr> <tr> <td>110</td> <td>6</td> <td>110</td> <td>1,1</td> </tr> <tr> <td>220</td> <td>3</td> <td>220</td> <td>0,55</td> </tr> <tr> <td>380</td> <td>2</td> <td></td> <td></td> </tr> <tr> <td>400</td> <td>1,5</td> <td></td> <td></td> </tr> <tr> <td>500</td> <td>1,5</td> <td></td> <td></td> </tr> <tr> <td>600</td> <td>1,2</td> <td></td> <td></td> </tr> </tbody> </table> (24,110,400 solo per serie "e")	Cat.AC15		Cat.DC13		Ue V	Ie A	Ue V	Ie A	24	10	24	5	48	8	48	2,7	60	6	60	2	110	6	110	1,1	220	3	220	0,55	380	2			400	1,5			500	1,5			600	1,2		
Cat.AC15		Cat.DC13																																											
Ue V	Ie A	Ue V	Ie A																																										
24	10	24	5																																										
48	8	48	2,7																																										
60	6	60	2																																										
110	6	110	1,1																																										
220	3	220	0,55																																										
380	2																																												
400	1,5																																												
500	1,5																																												
600	1,2																																												

Durata elettrica

Secondo UL 508
Corrente alternata 50-60 Hz cat AC15

- 500 V
- 380 V
- 220 V
- 127 V
- 12/48 V

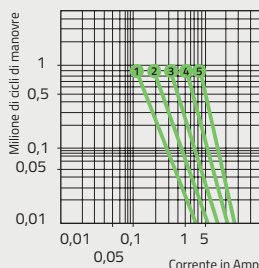

Corrente continua cat DC 13

- 400 V
- 220 V
- 110 V
- 48 V
- 24/12 V

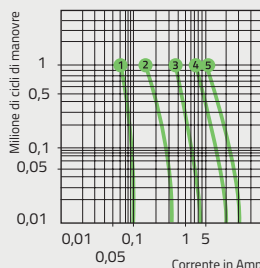

Affidabilità elettrica (percentuale di guasto)

Secondo EN/IEC 947-5-4
 Contatti 020 E10/E01 12V-5mA <10⁻⁸
 Contatti 020 E10AU/E01AU 5V-1mA <10⁻⁷

Porta lampada operatori luminosi

Attacco BA9S: lampade incandescenza, neon, multiled. Potenze raccomandate: lampade 2,6 W pulsanti, selettori 1,2 W

Durata lampade

Incandescenza ≤1000h-Neon ≤3000h
Multiled ≥50.000h

Configurazione contatti



Max N° 2 CONTATTI
Selettori luminosi.



Max N° 4 CONTATTI
Pulsanti stabili, pulsanti doppi, manipolatori, emergenza ad aggancio.



Max 6 CONTATTI
Pulsanti non luminosi, pulsanti luminosi, pulsanti a fungo momentanei, selettori

Electrical features

Rated insulation voltage	Ui 690 V pollution degree 3 in compliance with EN/IEC 60947-1																																												
Impulse withstand voltage	Uimp 4kV in compliance with EN/IEC 60947-1																																												
Rated thermal current	Ith10A in compliance with EN/IEC 60947-5-1																																												
Short circuit protection	Fuses DIAZED 10 A operating class gLgG shape D II in conformity with IEC 60269-1																																												
Contact material	Contact pads on Ag 1000/1000 for models Au: Ag 1000/1000, gold plated																																												
Electrical ratings	In compliance with EN/IEC 947-5-1 <table border="1"> <thead> <tr> <th colspan="2">Cat.AC15</th> <th colspan="2">Cat.DC13</th> </tr> <tr> <th>Ue V</th> <th>Ie A</th> <th>Ue V</th> <th>Ie A</th> </tr> </thead> <tbody> <tr> <td>24</td> <td>10</td> <td>24</td> <td>5</td> </tr> <tr> <td>48</td> <td>8</td> <td>48</td> <td>2,7</td> </tr> <tr> <td>60</td> <td>6</td> <td>60</td> <td>2</td> </tr> <tr> <td>110</td> <td>6</td> <td>110</td> <td>1,1</td> </tr> <tr> <td>220</td> <td>3</td> <td>220</td> <td>0,55</td> </tr> <tr> <td>380</td> <td>2</td> <td></td> <td></td> </tr> <tr> <td>400</td> <td>1,5</td> <td></td> <td></td> </tr> <tr> <td>500</td> <td>1,5</td> <td></td> <td></td> </tr> <tr> <td>600</td> <td>1,2</td> <td></td> <td></td> </tr> </tbody> </table> (24,110,400 for series "e" only)	Cat.AC15		Cat.DC13		Ue V	Ie A	Ue V	Ie A	24	10	24	5	48	8	48	2,7	60	6	60	2	110	6	110	1,1	220	3	220	0,55	380	2			400	1,5			500	1,5			600	1,2		
Cat.AC15		Cat.DC13																																											
Ue V	Ie A	Ue V	Ie A																																										
24	10	24	5																																										
48	8	48	2,7																																										
60	6	60	2																																										
110	6	110	1,1																																										
220	3	220	0,55																																										
380	2																																												
400	1,5																																												
500	1,5																																												
600	1,2																																												

Electrical durability

In compliance with UL 508
Alternated current 50-60 Hz cat AC15

- 500 V
- 380 V
- 220 V
- 127 V
- 12/48 V

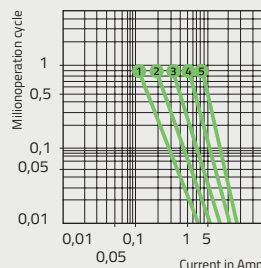

Direct current cat DC 13

- 400 V
- 220 V
- 110 V
- 48 V
- 24/12 V

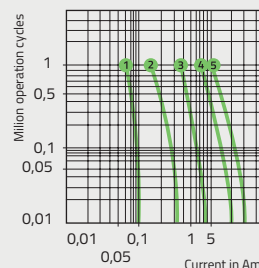

Electrical reliability (failure percentage)

In compliance with EN/IEC 947-5-4
 Contact 020 E10/E01 12V-5mA <10⁻⁸
 Contact 020 E10AU/E01AU 5V-1mA <10⁻⁷

Lamp holder illuminated operators

BA9S socket: incandescent, neon, multiled lamps
Recommended power: lamps 2.6W push-buttons, selector switches 1.2W

Lamp life

Incandescent ≤1000h-Neon ≤3000h
Multiled ≥50.000h

Contact configuration



Max 2 CONTACTS
Illuminated selector switches.



Max 4 CONTACTS
Maintained push-buttons, twin push-buttons, joysticks latching emergency push-buttons.



Max 6 CONTACTS
Metal bezel series: Non-illuminated push-buttons, momentary mushroom push-buttons, selector switches.

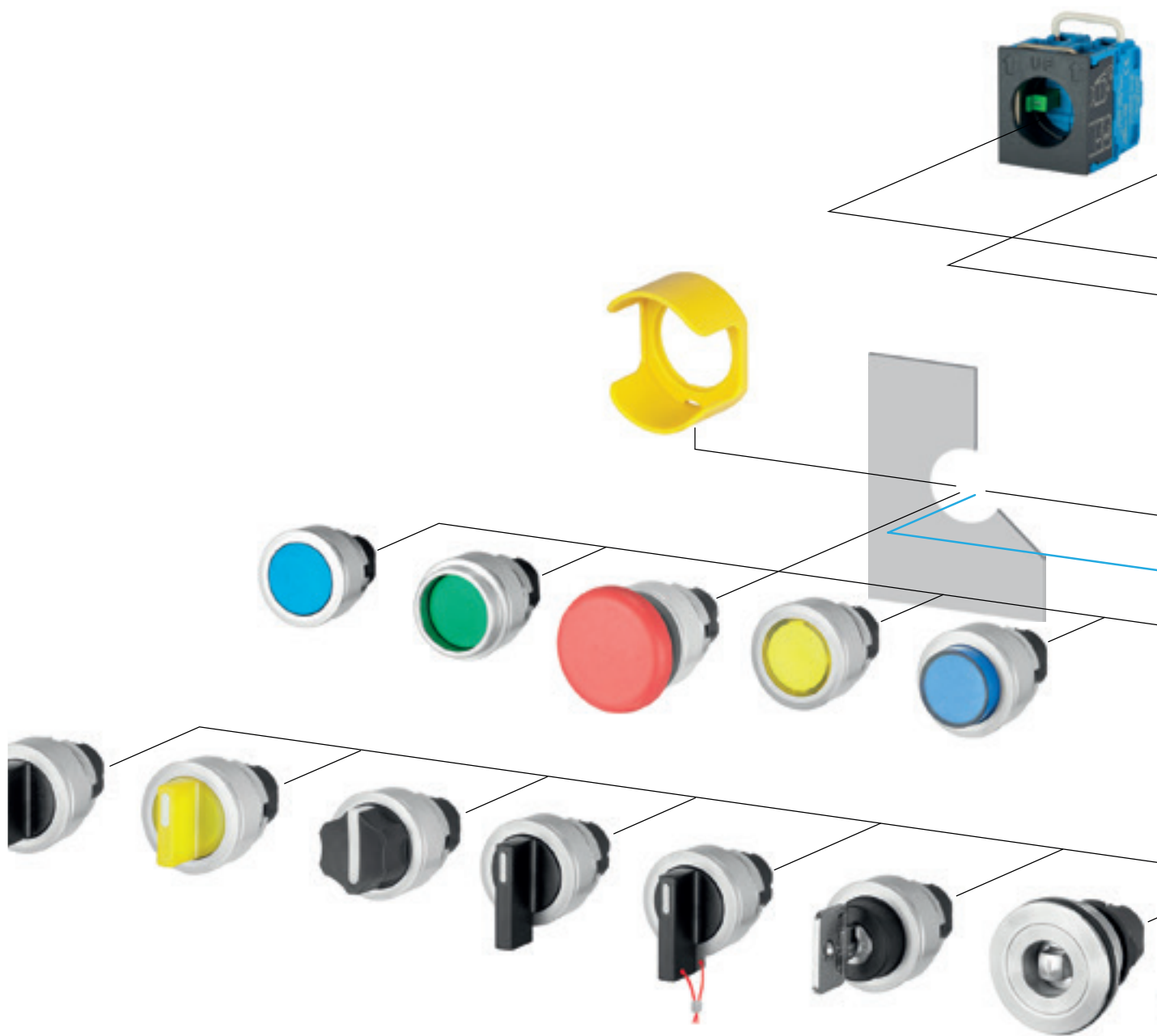

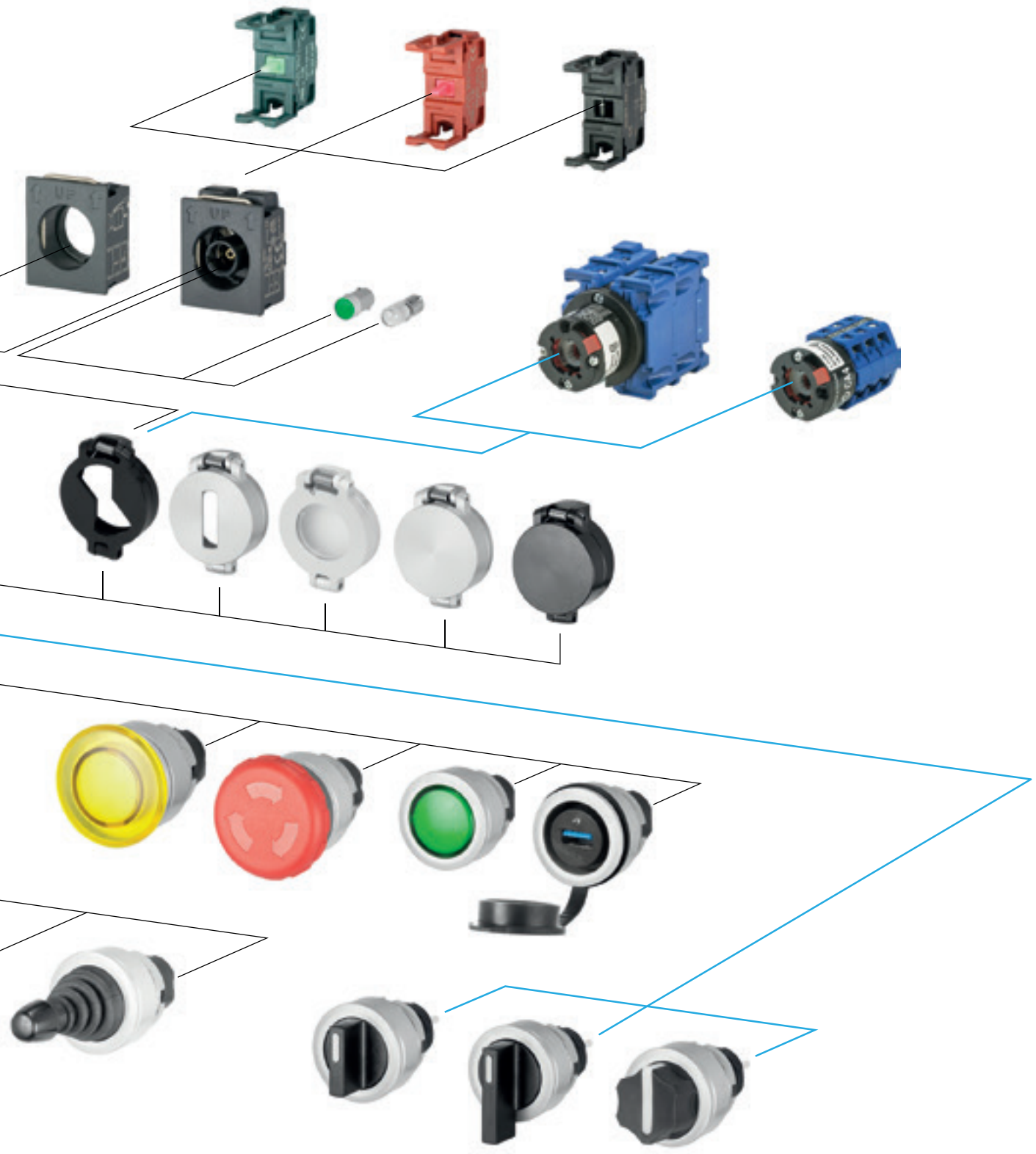

Pulsanti normali Ø30

Normal push-buttons Ø30

Pulsanti normali / Normal push-buttons

g

cod

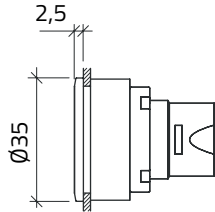

Pulsanti con guardia / Guarded push-buttons

● Nero / Black	34	030PPFIN
● Rosso / Red	34	030PPFIR
● Verde / Green	34	030PPFIV
● Giallo / Yellow	34	030PPFIG
● Blu / Blue	34	030PPFIBL
○ Bianco / White	34	030PPFIB

Stabili / Maintained

● Nero / Black	34	030PPFIN
● Rosso / Red	34	030PPFIR
● Verde / Green	34	030PPFIV
● Giallo / Yellow	34	030PPFIG
● Blu / Blue	34	030PPFIBL
○ Bianco / White	34	030PPFIB

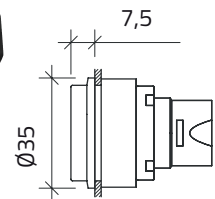

Pulsanti con guardia estesa / Push-buttons with extended guard

● Nero / Black	37	030PFGEN
● Rosso / Red	37	030PFGER
● Verde / Green	37	030PFGEV
● Giallo / Yellow	37	030PFGEY
● Blu / Blue	37	030PFGEBL
○ Bianco / White	37	030PFGEB

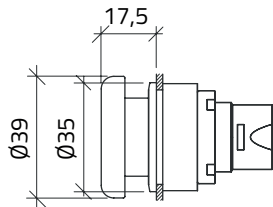

Pulsanti a fungo Ø40 / Mushroom push-buttons Ø40

● Nero / Black	48	030PFAFMN
● Rosso / Red	48	030PFAFMR
● Verde / Green	48	030PFAFMV
● Giallo / Yellow	48	030PFAFMG

Pulsanti luminosi Ø30

Illuminated push-buttons Ø30

Pulsanti luminosi / Illuminated push-buttons

g

cod

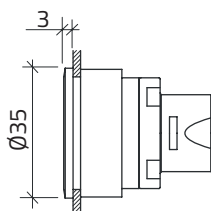

Pulsanti con guardia / Guarded push-buttons

● Rosso / Red	34	030PFLIR
● Verde / Green	34	030PFLIV
● Giallo / Yellow	34	030PFLIG
● Blu / Blue	34	030PFLIBL
○ Trasparente / Clear	34	030PFLII

Stabili / Maintained

● Rosso / Red	34	030PPFLIR
● Verde / Green	34	030PPFLIV
● Giallo / Yellow	34	030PPFLIG
● Blu / Blue	34	030PPFLIBL
○ Trasparente / Clear	34	030PPFLII

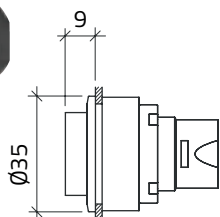

Pulsanti sporgenti / Projecting push-buttons

● Rosso / Red	34	030PFLSR
● Verde / Green	34	030PFLSV
● Giallo / Yellow	34	030PFLSG
● Blu / Blue	34	030PFLSBL
○ Trasparente / Clear	34	030PFLSI

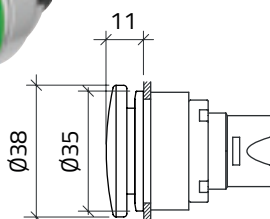

Pulsanti a fungo Ø38 / Mushroom push-buttons Ø38

● Rosso / Red	38	030PFAFLR
● Verde / Green	38	030PFAFLV
● Giallo / Yellow	38	030PFAFLG

Pulsanti di emergenza Ø30

Emergency stop push-buttons Ø30

Pulsanti di emergenza a fungo Ø40

Emergency stop mushroom push-buttons Ø40

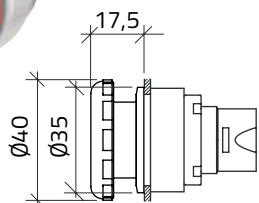
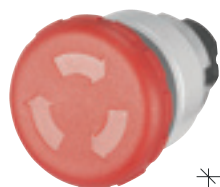

Aggancio rapido (sgancio rotazione)

Fast latching (rotation release)

● Nero / Black	49	030PFAAN
● Rosso / Red	49	030PFAAR

g

cod

Lampade spia Ø30 Pilot lights Ø30

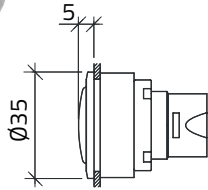

Lampade spia / Pilot lights

	g	cod
● Rosso / Red	33	030LFIR
● Verde / Green	33	030LFIV
● Giallo / Yellow	33	030LFIG
● Blu / Blue	33	030LFIBL
○ Bianco / White	33	030LFIB
● Arancio / Orange	33	030LFIA

Selettori a manopola Ø30 Knob selector switches Ø30

Cercare la combinazione di schemi a pag. 20 / See diagram combination on page 20

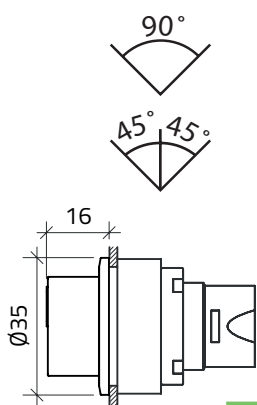

2 posizioni / 2 positions



CAM A

g

cod

39

030SFMAN



CAM B

39

030SFMBN



39

030SFMBND

3 posizioni / 3 positions

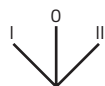

CAM O

g

cod

39

030SFMON

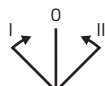

39

030SFMONC

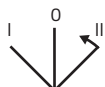

39

030SFMOND

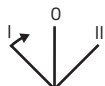

39

030SFMONS

Selettori luminosi a manopola Ø30 Illuminated selector switches Ø30

Cercare la combinazione di schemi a pag. 20 / See diagram combination on page 20

2 posizioni / 2 positions





CAM A

○ Bianco / White	36	030SFMLAB
● Rosso / Red	36	030SFMLAR
● Verde / Green	36	030SFMLAV
● Giallo / Yellow	36	030SFMLAG
● Blu / Blue	36	030SFMLABL

g

cod

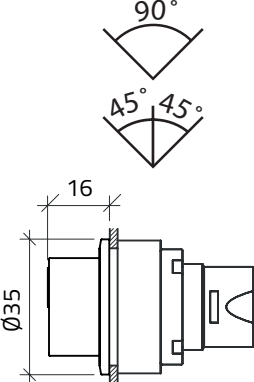

3 posizioni / 3 positions



CAM O

○ Bianco / White	36	030SFMLOB
● Rosso / Red	36	030SFMLOR
● Verde / Green	36	030SFMLOV
● Giallo / Yellow	36	030SFMLOG
● Blu / Blue	36	030SFMLOBL

g

cod



CAM O

○ Bianco / White	36	030SFMLOBC
● Rosso / Red	36	030SFMLORC
● Verde / Green	36	030SFMLOVC
● Giallo / Yellow	36	030SFMLOGC
● Blu / Blue	36	030SFMLOBLC

Selettori luminosi a manopola Ø30

Illuminated knob selector switches Ø30

Cercare la combinazione di schemi a pag. 20 / See diagram combination on page 20



2 posizioni / 2 positions

g

cod

CAM A

○ Bianco / White	36	030SFPLAB
● Rosso / Red	36	030SFPLAR
● Verde / Green	36	030SFPLAV
● Giallo / Yellow	36	030SFPLAG

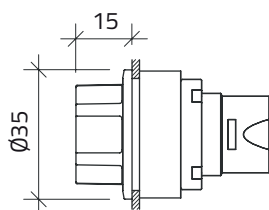
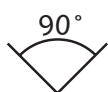

3 posizioni / 3 positions

g

cod

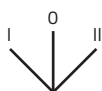

CAM O

○ Bianco / White	36	030SFPL0B
● Rosso / Red	36	030SFPL0R
● Verde / Green	36	030SFPL0V
● Giallo / Yellow	36	030SFPL0G

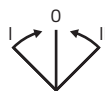





CAM O

○ Bianco / White	36	030SFPL0BC
● Rosso / Red	36	030SFPL0RC
● Verde / Green	36	030SFPL0VC
● Giallo / Yellow	36	030SFPL0GC

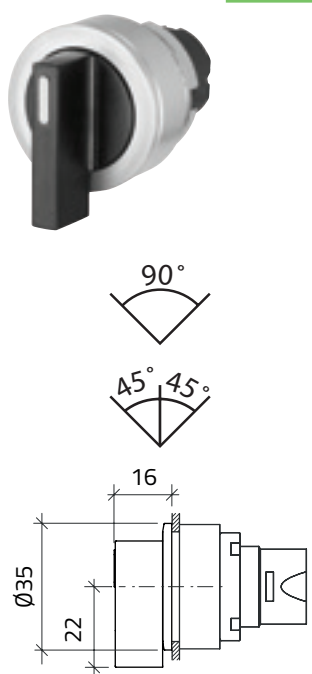
Selettori a leva Ø30 Lever selector switches Ø30

Cercare la combinazione di schemi a pag. 20 / See diagram combination on page 20

		2 posizioni / 2 positions		
		g	cod	
	 CAM A	39	030SFLAN	
	 CAM B	39	030SFLBN	
		39	030SFLBND	
			3 posizioni / 3 positions	
			g	cod
	 CAM O	39	030SFLON	

Commutatore rotativo 10A Ø30

Rotary selector switches 10A Ø30



Commutatore rotativo a leva corta
Short lever rotary selector switch

Schema 401 / Diagram 401

g

cod

59

030SFMNSC401



Commutatore rotativo a leva lunga
Long lever rotary selector switch

Schema 401 / Diagram 401

g

cod

59

030SFLNSC401



Commutatore rotativo a manopola
Knob rotary selector switch

Schema 401 / Diagram 401

g

cod

59

030SFPNSC401

ESEMPIO SCHEMA 401

EXAMPLE DIAGRAM 401

Per altri schemi consultare il nostro ufficio commerciale / For further diagram contact our commercial office

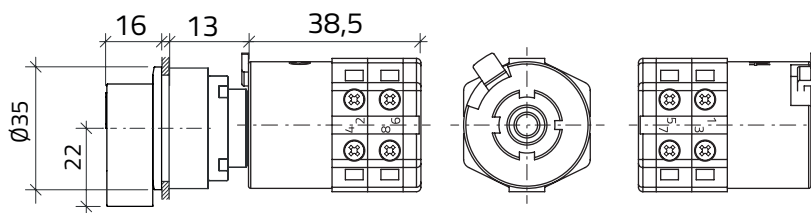
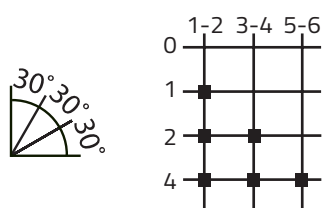

Selettori a chiave Ø30 Key selector switches Ø30

Cercare la combinazione di schemi a pag. 20 / See diagram combination on page 20

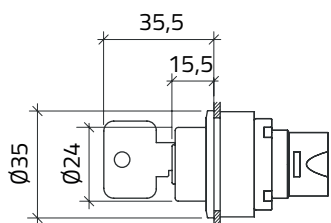

2 posizioni / 2 positions

g	k	cod	k	cod
CAM A				
82		030SFCA		030SFCA2
82		030SFCA4		
CAM B				
82		030SFCB		030SFCB2
82		030SFCBD		

3 posizioni / 3 positions

g	k	cod	k	cod
CAM O				
82		030SFCO		030SFCO2
82		030SFCO3		030SFCO4
82		030SFCOC		
82		030SFCOD		

Chiavi speciali Special key



c	suf
Chiave standard 3095, per chiavi speciali far seguire al codice del selettore il suffisso Standard key 3095, for special keys complete the selector code with the suffix	
● Nero / Black	73034 K34
● Rosso / Red	73037 K37
● Giallo / Yellow	73033 K33
● Blu / Blue	73038 K38
● Arancio / Orange	73040 K40
	3353 K53
	9901 K01
	9902 K02
	9903 K03
	9904 K04
	9905 K05
	9910 K10
	9916 K16
	9919 K19

Selettori a chiave quadra Ø30 Square key selector switches Ø30

Cercare la combinazione di schemi a pag. 20 / See diagram combination on page 20

2 posizioni / 2 positions



CAM B

g

cod

170

030SFCQB

200

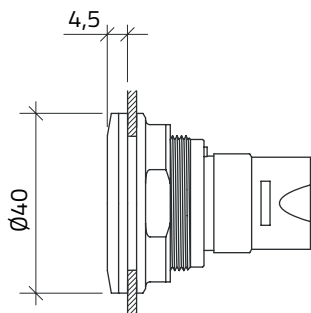

Combinazione di schemi Ø30 Diagram combination Ø30

			Schema Diagram		Contatti flangianti Flanged contacts
	CAM A	 13 — 14	 E10		020E10 020G
	CAM A	 21 — 22 13 — 14	 E01 E10		020E01 020E10 020G
	CAM B	 21 — 22 13 — 14	 E01 E10		020E01 020E10 020G
	CAM O	 23 — 24 13 — 14	 E10 E10		020E10 020E10 020G

Presa USB filopannello 3.0 Ø30 3.0 flushmount USB socket Ø30

Presa USB 3.0
3.0 USB socket

g

cod

Tipo A-A (femmina-femmina)
A-A type (female-female)

● Nero / Black

39

030PFUSB

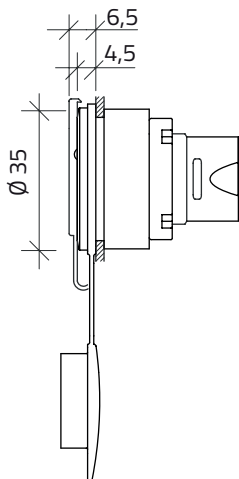

Cavo USB USB cable

Cavo mt 0,8
Cable mt 0,8

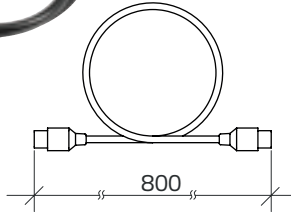

Tipo M-M (maschio-maschio)
Type M-M (male-male)

● Nero / Black

g cod
37 010CUSBMM8

Cavo mt 2
Cable mt 2

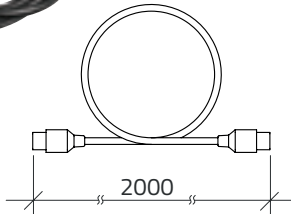

Tipo M-M (maschio-maschio)
Type M-M (male-male)

● Nero / Black

g cod
77 010CUSBMM20

Manipolatori Ø30 Joysticks Ø30

032

2 posizioni / 2 positions

g cod



1-2	permanenti/maintained	40	030MF2P
1-2	temporanee/spring return	40	030MF2T

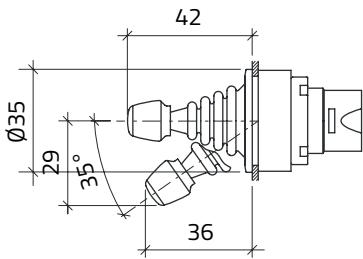

4 posizioni / 4 positions

g cod

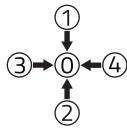

1-2-3-4	permanenti/maintained	40	030MF4P
1-2-3-4	temporanee/spring return	40	030MF4T

Schema Diagram

Contatti flangianti Flanged contacts

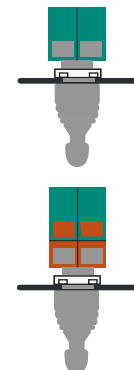
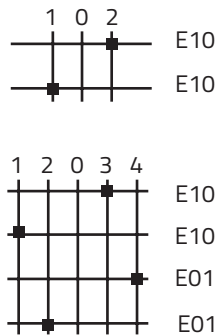
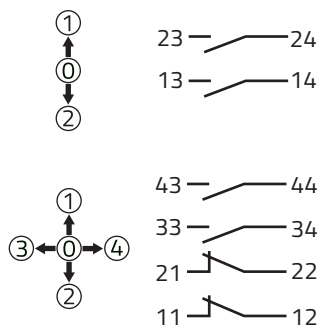











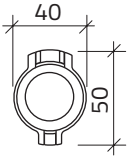

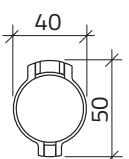
020E10
020E10
020G

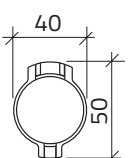
020E10
020E10
020E01
020E01
020G

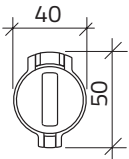

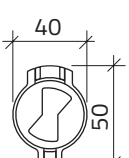
Accessori Ø30 Accessories Ø30

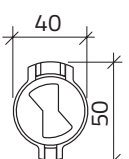
Protezioni in alluminio piombabili Sealable aluminum covers

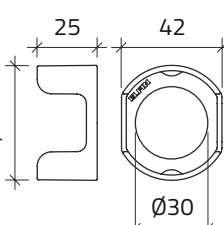
			g	cod
		Per pulsanti / For push-buttons Alluminio / Aluminium	12	030PFPLPA
		Per pulsanti / For push-buttons Alluminio / Aluminium ● Nero / Black	15 15	030PFPPA 030PFPP
		Per pulsanti sporgenti / For projecting push-buttons Alluminio / Aluminium ● Nero / Black	19 19	030PFPSPA 030PFPS
		Per selettori con blocco / For selector switches with lock Alluminio / Aluminium ● Nero / Black	14 14	030PFPSBA 030PFPS
		Per abilitazione selettore a DX / For selector enable to RH ● Nero / Black	12	030PFPS2P-0D
		Per abilitazione selettore a SX / For selector enable to SH ● Nero / Black	12	030PFPS2P-S0
		Ghiere di protezione pulsanti a fungo Guards for mushroom push-buttons ● Grigio / Grey ● Giallo / Yellow		030GPF42 030GPF42G

Portalampana BA9S Lampholders BA9S

Portalampana / Lampholders

g n cod



~ = Alimentazione diretta / Direct supply



IEC: BA9S 380V. max 2W esclusa / excluded
Valori certificati IMQ / IMQ certified values
UL - CSA: BA9S 250V. max 2W esclusa / excluded

16 10 020PD9

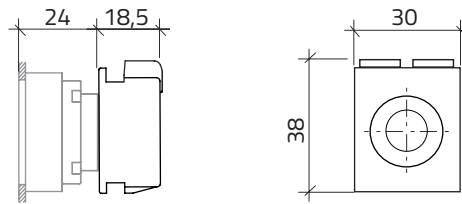

~ = Alimentazione diretta / Direct supply

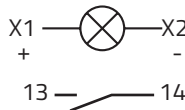

IEC: BA9S 380V. max 2W esclusa / excluded
Valori certificati IMQ / IMQ certified values
UL - CSA: BA9S 250V. max 2W esclusa / excluded
1 NO Aperto / Open

26 5 020PD910

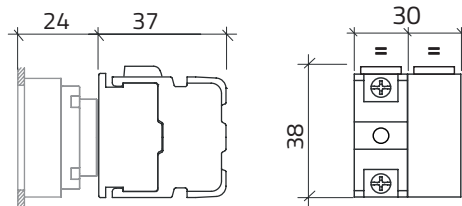

~ = Alimentazione diretta / Direct supply

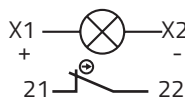

IEC: BA9S 380V. max 2W esclusa / excluded
Valori certificati IMQ / IMQ certified values
UL - CSA: BA9S 250V. max 2W esclusa / excluded
1 NC Chiuso / Closed

26 5 020PD901

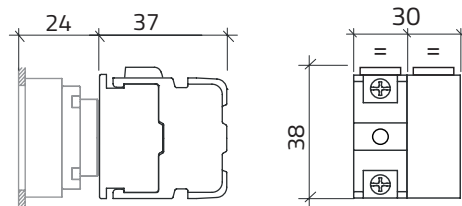

~ = Alimentazione diretta / Direct supply

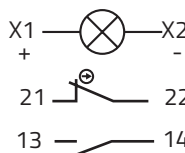

IEC: BA9S 380V. max 2W esclusa / excluded
Valori certificati IMQ / IMQ certified values
UL - CSA: BA9S 250V. max 2W esclusa / excluded
1 NC Chiuso / Closed
1 NO Aperto / Open

26 5 020PD911

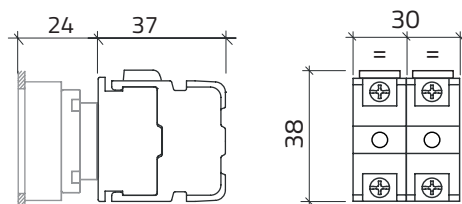

Portalampana BA9S Lampholders BA9S

Portalampana / Lampholders



Alimentazione diretta / Direct supply



g n cod

37 5 020PD920

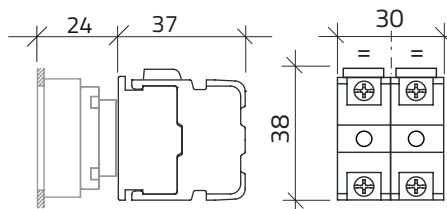

Elemento prova lampada / Lamp test module

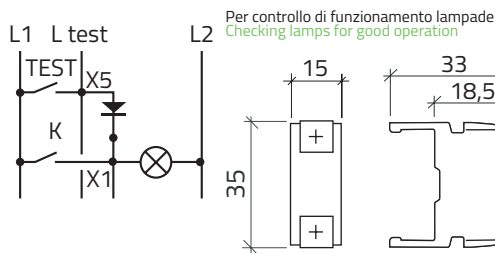

16 020ET

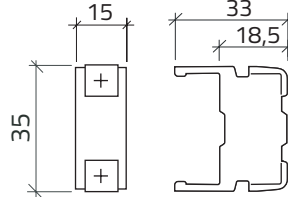

Elementi di contatto

Contact blocks

Elementi di contatto / Contact blocks

g **n** **cod**

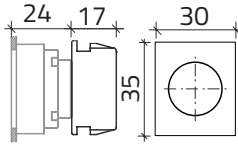

Flangia per contatti / Flange for contacts

8 10 **020G**

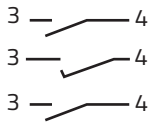

1 NO

10 10 **020E10**



1 NO Chiusura anticipata / 1 NO Early make

10 5 **020E10A**



1 NO

10 5 **020E10AU**

Contatti dorati e viti terminali inox. Idoneo per ambienti con fenomeni di corrosione
Gold-plated contacts and stainless steel terminal screws suitable for corrosive environment

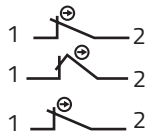
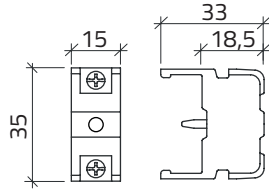

1 NC

10 10 **020E01**



1 NC Apertura ritardata / 1 NC Late break

10 5 **020E01R**



1 NC

10 5 **020E01AU**

Contatti dorati e viti terminali inox. Idoneo per ambienti con fenomeni di corrosione
Gold-plated contacts and stainless steel terminal screws suitable for corrosive environment

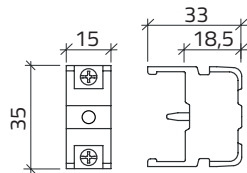

1 NO con flangia / 1NO with flange

19 5 **020GE10**

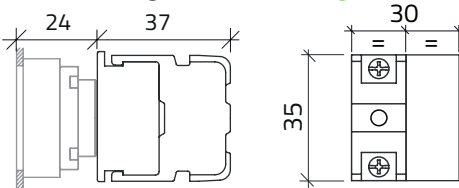

1 NC con flangia / 1NC with flange

19 5 **020GE01**

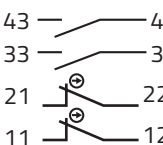
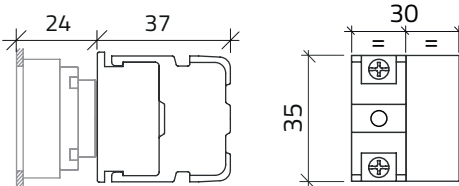

1 NC con flangia / 1NC with flange





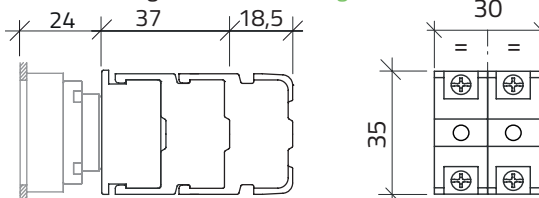



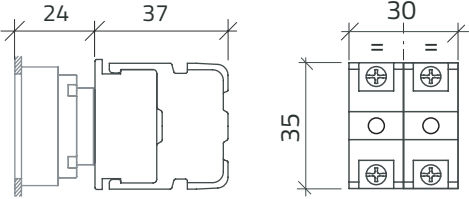

50 **020GE22**

1 NO con flangia / 1NO with flange

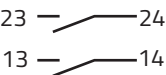
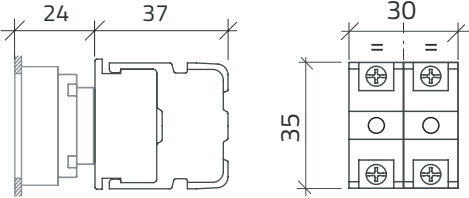

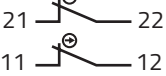
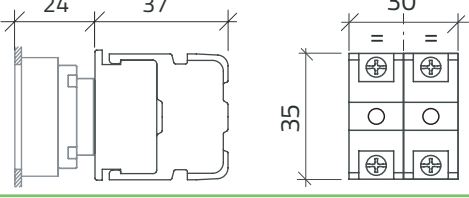
Elementi di contatto Contact blocks

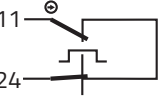
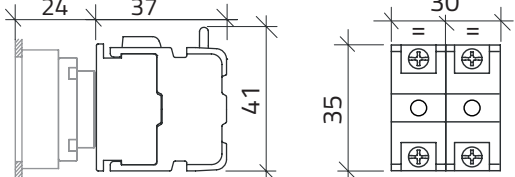
Elementi di contatto / Contact blocks

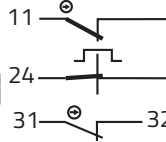
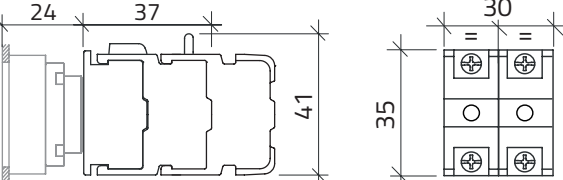
			g	n	cod
	 <p>21 — 22 13 — 14</p> <p>1 NC con flangia / 1NC with flange 1 NO con flangia / 1NO with flange</p>		19	5	020GE11
					
	 <p>23 — 24 13 — 14</p> <p>1 NO con flangia / 1NO with flange 1 NO con flangia / 1NO with flange</p>		19	5	020GE20
					
	 <p>21 — 22 11 — 12</p> <p>1 NC con flangia / 1NC with flange 1 NC con flangia / 1NC with flange</p>		19	5	020GE02
					
	 <p>11 — 24</p> <p>Elemento di contatto con automonitoraggio Contact block with self-monitoring</p>		19	5	020GE01S
					
	 <p>11 — 24 31 — 32</p> <p>Elemento di contatto con automonitoraggio Contact block with self-monitoring</p>		19	5	020GE02S
					

Lampadine Lamps

032

BA9S Led luce fissa BA9SLed fixed light

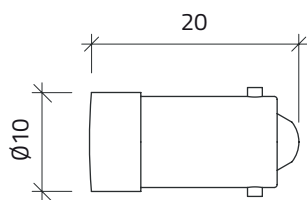

	g	n	cod
6V AC-DC			
● Rosso / Red	2	5	010BA9SLR6
● Giallo / Yellow	2	5	010BA9SLG6
● Verde / Green	2	5	010BA9SLV6
● Blu / Blue	2	5	010BA9SLBL6
○ Bianco / White	2	5	010BA9SLB6
12V AC-DC			
● Rosso / Red	2	5	010BA9SLR12
● Giallo / Yellow	2	5	010BA9SLG12
● Verde / Green	2	5	010BA9SLV12
● Blu / Blue	2	5	010BA9SLBL12
○ Bianco / White	2	5	010BA9SLB12
24V AC-DC			
● Rosso / Red	2	5	010BA9SLR24
● Giallo / Yellow	2	5	010BA9SLG24
● Verde / Green	2	5	010BA9SLV24
● Blu / Blue	2	5	010BA9SLBL24
○ Bianco / White	2	5	010BA9SLB24
36V AC-DC			
● Rosso / Red	2	5	010BA9SLR36
● Giallo / Yellow	2	5	010BA9SLG36
● Verde / Green	2	5	010BA9SLV36
● Blu / Blue	2	5	010BA9SLBL36
○ Bianco / White	2	5	010BA9SLB36
48V AC-DC			
● Rosso / Red	2	5	010BA9SLR48
● Giallo / Yellow	2	5	010BA9SLG48
● Verde / Green	2	5	010BA9SLV48
● Blu / Blue	2	5	010BA9SLBL48
○ Bianco / White	2	5	010BA9SLB48
130V AC-DC			
● Rosso / Red	2	5	010BA9SLR110
● Giallo / Yellow	2	5	010BA9SLG110
● Verde / Green	2	5	010BA9SLV110
● Blu / Blue	2	5	010BA9SLBL110
○ Bianco / White	2	5	010BA9SLB110
240V AC-DC			
● Rosso / Red	2	5	010BA9SLR240
● Giallo / Yellow	2	5	010BA9SLG240
● Verde / Green	2	5	010BA9SLV240
● Blu / Blue	2	5	010BA9SLBL240
○ Bianco / White	2	5	010BA9SLB240
400V AC-DC			
● Rosso / Red	2	5	010BA9SLR400
● Giallo / Yellow	2	5	010BA9SLG400
● Verde / Green	2	5	010BA9SLV400
● Blu / Blue	2	5	010BA9SLBL400
○ Bianco / White	2	5	010BA9SLB400



Lampadine Lamps

Led <60V non polarizzati 110-240 V polarizzati Led lamps <60V non polarized 110-240 V polarized

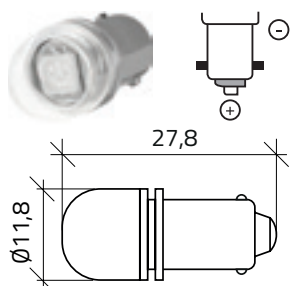

Led luce lampeggiante / *Flashing light led*
 Led ultraluminoso tensioni ±15% non polarizzata / *Ultra-bright led voltages ± 15% non polarized*
 AC-DC 6 12 24 48 110 AC 220 mA 30 20 14 7 5 16

24V AC-DC

● Rosso / *Red* 2 **010BA9SLLR24**

130V AC-DC

● Rosso / *Red* 2 **010BA9SLLR110**

240V AC-DC

● Rosso / *Red* 2 **010BA9SLLR220**

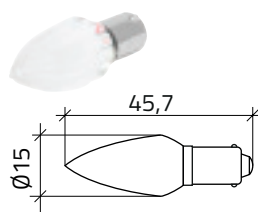

24V AC-DC

● Rosso / *Red* 2 **010BA9ALLR24**

Nuove lampade due colori , tecnologia led alta luminosità New bi-colour led lamps, high brightness

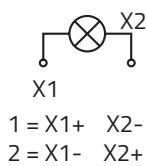

24V DC 15mA

1 2

● ● Verde, rosso / *Green, red* 2 **010BA9SLVR24**
 ● ● Verde, giallo / *Green, yellow* 2 **010BA9SLVG24**
 ● ● Blu, rosso / *Blue, red* 2 **010BA9SLBLR24**
 ● ● Blu, giallo / *Blue, yellow* 2 **010BA9SLBLG24**

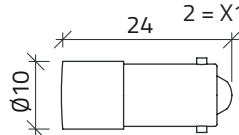

BA9S lampadine ad incandescenza BA9S Incandescent lamps

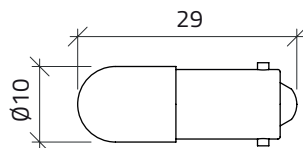

V	W	g	n	cod
6V	0,6W	1,3	10	010BA9S6V-0.6W
24V	1,2 w	1,3	10	010BA9S24V-1.2W
24V	3W	1,3	10	010BA9S24V-3W
30V	1,2W	1,3	10	010BA9S30V-1.2W
30V	3W	1,3	10	010BA9S30V-3W
48V	1,2W	1,3	10	010BA9S48V-1.2W
60V	1,2 w	1,3	10	010BA9S60V-1.2W
60V	3W	1,3	10	010BA9S60V-3W
110V	1,9W	1,3	10	010BA9S130V-1.9
220V	2W	1,3	10	010BA9S220V-2W

BA9S Lampadine al neon / BA9S neon lamps

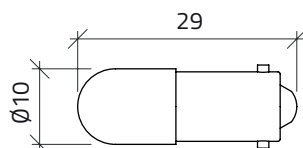

Neon AC

Color	V	W	g	n	cod
● Arancio / <i>Orange</i>	65V	0,05W	2,3	10	010BA9SN65
● Arancio / <i>Orange</i>	130V	0,1W	2,3	10	010BA9SN110
● Verde / <i>Green</i>	130V	0,1W	2,3	10	010BA9NV110
● Arancio / <i>Orange</i>	240V	0,3W	2,3	10	010BA9SN220
● Verde / <i>Green</i>	240V	0,3W	2,3	10	010BA9NV220
● Arancio / <i>Orange</i>	400V	0,5W	2,3	10	010BA9SN380
● Verde / <i>Green</i>	400V	0,5W	2,3	10	010BA9NV380