

System Techno

The Techno protective fence system, Ø3 mm wire, Ø4 mm wire and INOX Ø3mm wire was created to help all customers determine the hazardous areas to provide a solution with steel material that is cost effective and easy to install.

This product is made with self-supporting grid panels, with a mesh size that improves visibility to the machine that stands behind the fence.



Cheap

The costs are minimized because it is made as a self-supporting fence.



Modularity

All components are modular; so the same panels can be used both as fixed elements and with the help of a Kit, as a double or sliding door.



Visibility

The innovative system of the 32x67 (wirenetting) improves the vision of the machinery inside the restricted area.



Modification on place during installation

This system has the big advantage to be changed on place, with the use of a few Tools and it does not have to be repainted afterwards.





The QUICK TECHNO kit is an instrument designed exclusively to reduce assembly time, it is possible to install this 3-prolongation kit by a single installer. The system complies with the applicable regulations. A fundamental requirement for permanent guards is their fixing, which must be obtained with systems that require the use of tools for opening them and, as far as possible, they must not be able to remain in their place in the absence of their fixing means.

At the end of the operations therefore the kit must necessarily be removed.



Step 1

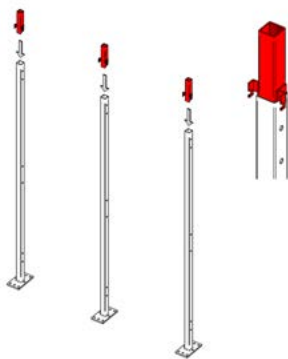

Step 2

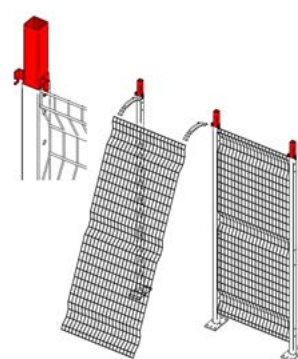

Step 3

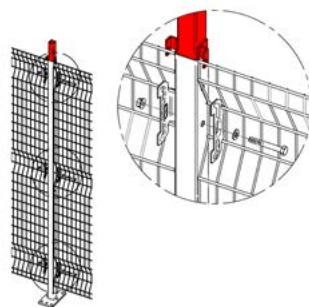

Step 4

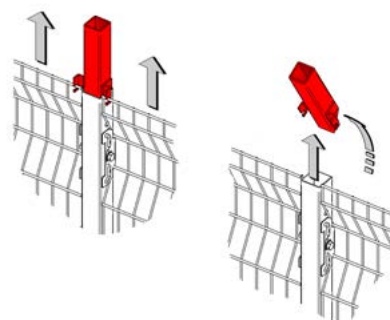

Step 5

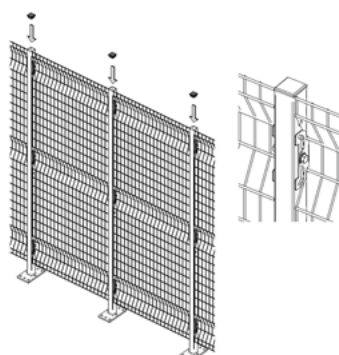

Video

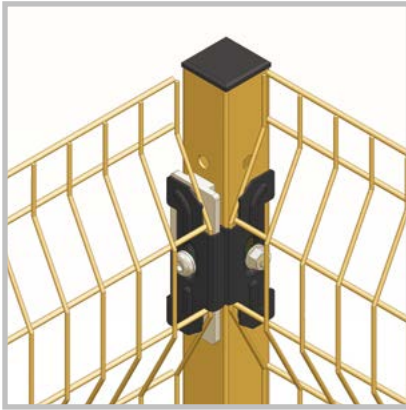

System **Techno****Convex corners kit**

With this accessory you can realize
Internal angle of 90°.

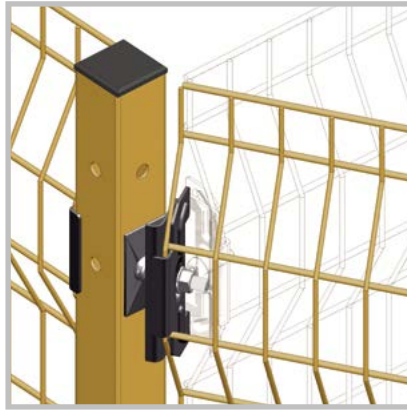
Panel inclination kit

With this accessory you can make
angle connections with inclinations
of 30° to 180°.

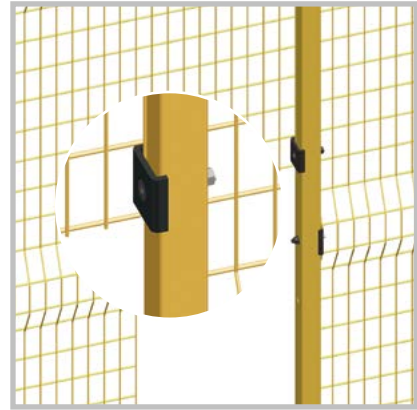
Panel fixing kit 1 fold

This accessory allows you to be able
to fix the panel to the posts later, af-
ter having changed or shortened it
horizontally.

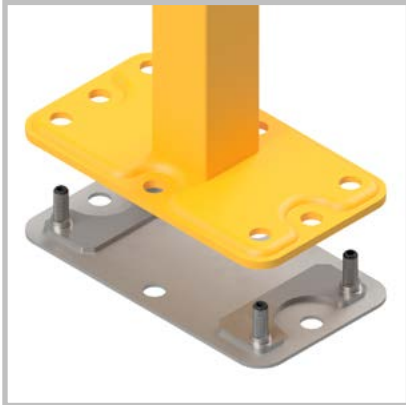
Leveling kit

This kit allows the leveling of the post.
Ideal for setting the door posts.

Posts 40x40**Posts 40x80**

Unlosable screw set

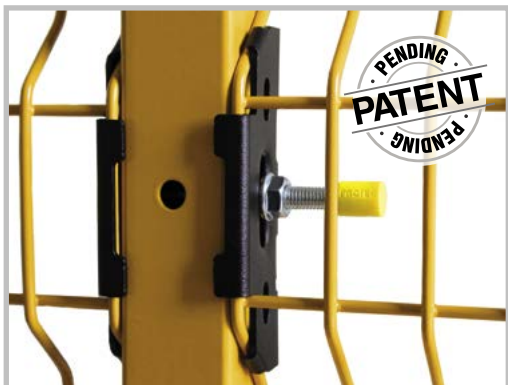

The new Machinery Directive requires that “fastening systems must remain attached to the fences or to the machine when removing the protections”.

The screws must not be missed unless the panel or panels need to be removed for normal maintenance and it is not possible to act on the access already provided (doors).

The standard UNI EN 14120 states: Movable protective equipment, if access frequency is high (more than once a week) or if removal of the fixed guard may be difficult, a movable guard with lock must be provided.

In accordance to current regulations, the set of non-removable screws is easy to install and it is always provided.

Intermediate screw kit



This kit contains 6 plates and corresponding screws for H 2000 8 plates and corresponding screws for H 2520.

Angle screw kit



This kit contains 6 plates and corresponding screws for H 2000 8 plates and corresponding screws for H 2520.

Terminal screw kit



This kit contains 3 plates and corresponding screws for H 2000 4 plates and corresponding screws for H 2520.

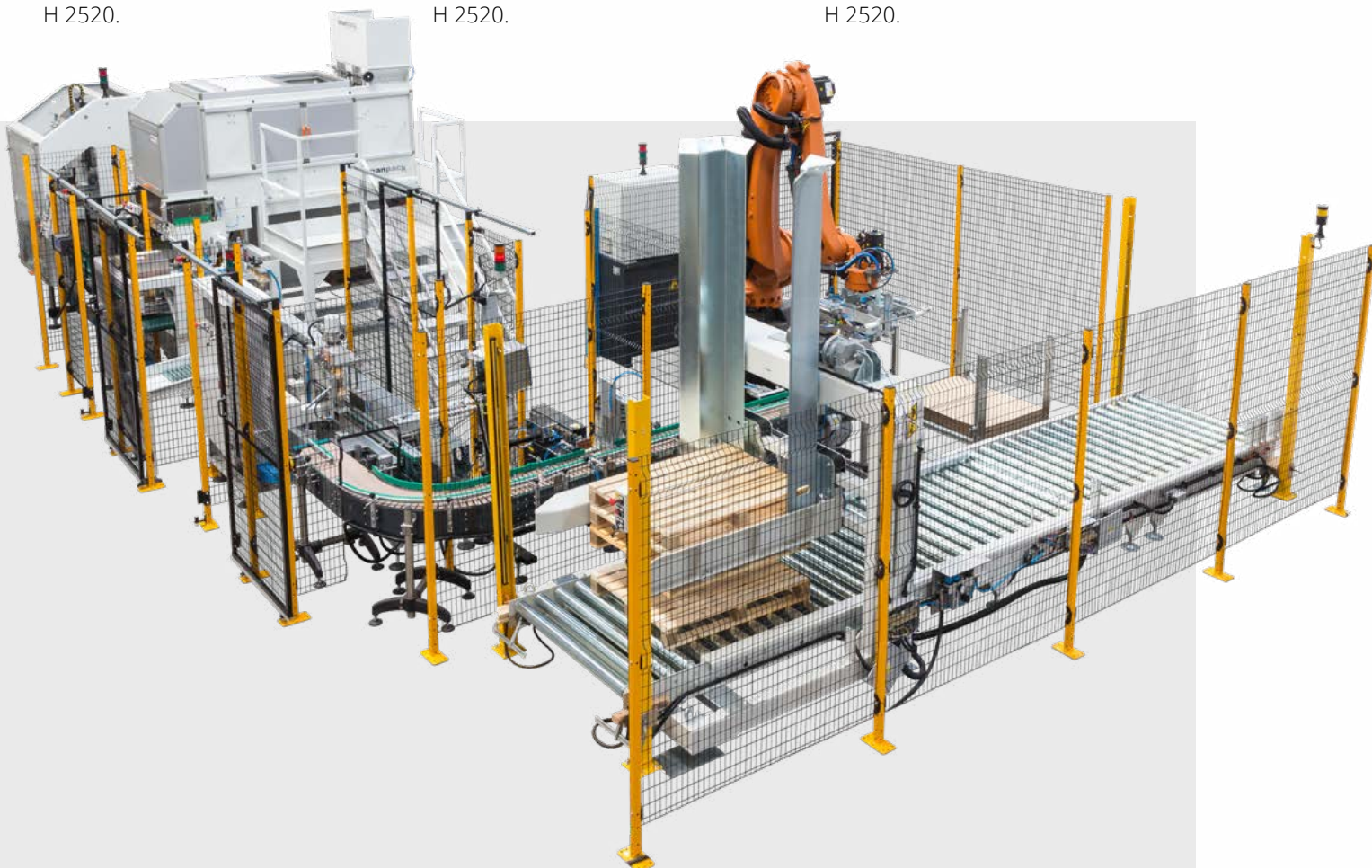

System **Techno wire** Ø3

Panels dimensions

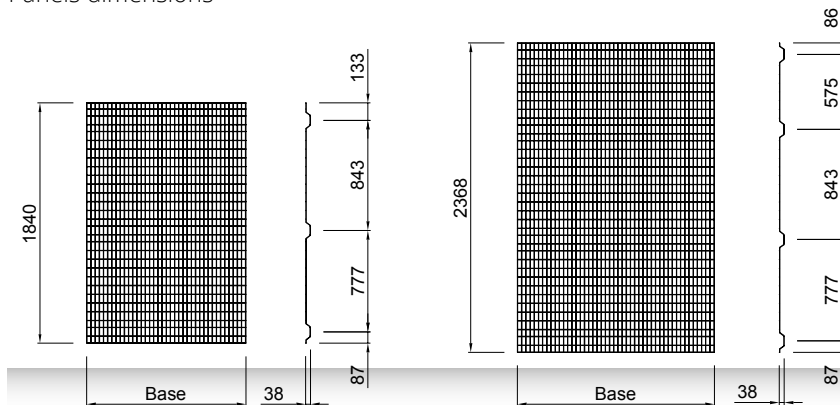

Post dimensions

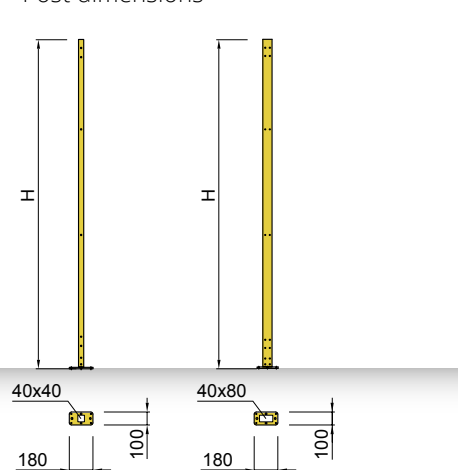

Mesh 32x67 mm wire Ø3 mm

Floor light 160 mm for panels - 100 mm for doors

Panels dimensions

	Art. Nr.	Base	Height	Color
	PNNT001	259	1840	RAL 1003
	PNNT002	419		
	PNNT003	707		
	PNNT004	1027		
	PNNT005	1219		
	PNNT006	1507		
	PNNT013	2019		
	PNNT008	259	2368	RAL 1003
	PNNT009	419		
	PNNT010	707		
	PNNT011	1027		
	PNNT012	1219		
	PNNT012	1219		
	PNNT007	1507		
Doors panels	PNNA 015	700	1900	RAL 9005 Scratchproof
	PNNA 016	1000		
	PNNA 017	1200		
	PNNA 018	1500		
Doors panels	PNNA2501	700	2405	RAL 9005 Scratchproof
	PNNA2502	1000		
	PNNA2503	1200		
	PNNA2504	1500		

Post dimensions

Art. No.	Height H	Cross Section	Plate	Color
MT113 (intermediate)	2000	40x40	100x180	RAL 1003
MATEC110 (angular)	2000	40x40	100x180	
MT2500 (intermediate)	2520	40x40	100x180	
MATEC2500 (angular)	2520	40x40	100x180	
MT502 (intermediate)	2000	40x80	100x180	RAL 1003
MATEC115 (angular)	2000	40x80	100x180	
MT507 (intermediate)	2520	40x80	100x180	
MATEC2501 (angular)	2520	40x80	100x180	
KRMT001 KA102ZN	Kit leveling for posts 40x40 - 40x80 Level plate dim. 100x180 sp. 25/10			

Stock colors for panels



Stock colors for panels and posts

