

Module for emergency stops and end position monitoring for movable guards

Main features

- For safety applications up to SIL CL 2/PL d
- Choice between automatic start, manual start (CS AR-40 only) or monitored start (CS AR-41 only)
- Reduced housing width of 22.5 mm
- 2 NO safety contacts
- Supply voltage: 24 Vac/dc

Utilization categories

Alternating current: AC15 (50...60 Hz)

U_e (V) 230

I_e (A) 3

Direct current: DC13 (6 oper. cycles/min.)

U_e (V) 24

I_e (A) 4

Quality marks:



EC type examination certificate: IMQ CP 432 DM

UL approval: E131787

CCC approval: 2013010305640211

EAC approval: RU C-IT.YT03.B.00035/19

Compliance with the requirements of:

Machinery Directive 2006/42/EC,

EMC Directive 2014/30/EC,

RoHS Directive 2011/65/EU.

Technical data

Housing

Polyamide housing PA 66, self-extinguishing V0 acc. to UL 94

Protection degree acc. to EN 60529:

IP40 (housing), IP20 (terminal strip)

Dimensions:

see page 317, design D

General data

SIL level (SIL CL) up to:

SIL CL 2 acc. to EN 62061

Performance Level (PL) up to:

PL d acc. to EN ISO 13849-1

Safety category up to:

cat. 2 acc. to EN ISO 13849-1

Safety parameters:

see page 375

Ambient temperature:

-25°C...+55°C

Mechanical endurance:

>10 million operating cycles

Electrical endurance:

>100,000 operating cycles

Pollution degree:

external 3, internal 2

Rated impulse withstand voltage (U_{imp}):

4 kV

Rated insulation voltage (U_i):

250 V

Overvoltage category:

II

Supply

Rated supply voltage (U_n):

24 Vac/dc; 50...60 Hz

Max. DC residual ripple in DC:

10%

Supply voltage tolerance:

±15% of U_n

Power consumption AC:

< 5 VA

Power consumption DC:

< 2 W

Control circuit

Protection against short circuits:

PTC resistance, I_h=0.5 A

PTC times:

Response time > 100 ms, release time > 3 s

Maximum resistance per input:

≤ 50 Ω

Current per input:

70 mA (typical)

Min. duration of start impulse t_{MIN}:

> 100 ms

Response time t_A:

< 50 ms

Release time in absence of power supply t_R:

< 105 ms

Simultaneity time t_C:

unlimited

In compliance with standards:

EN 60204-1, EN ISO 13855, EN 1037, EN ISO 12100, EN ISO 13850, EN 60529, EN 61000-6-2, EN 61000-6-3, EN 61326-1, EN 60664-1, EN 60947-1, EN 50581, EN ISO 13849-1, EN ISO 13849-2, EN ISO 62061, UL 508, CSA C22.2 n° 14-95, GB/T14048.5-2017

Output circuit

Output contacts:

2 NO safety contacts

Contact type:

forcibly guided

Material of the contacts:

silver alloy

Maximum switching voltage:

230/240 Vac; 300 Vdc

Max. current per contact:

6 A

Conventional free air thermal current I_{th}:

6 A

Max. total current Σ I_{th}²:

36 A²

Minimum current:

10 mA

Contact resistance:

≤ 100 mΩ

External protection fuse:

4 A

The number and the load capacity of output contacts can be increased by using expansion modules or contactors. See pages 263-272.

Code structure

CS AR-40V024

Start mode

40 manual or automatic start

41 monitored start

Supply voltage

024 24 Vac/dc

Connection type

V Screw terminals

M Connector with screw terminals

X Connector with spring terminals

Features approved by UL

Rated supply voltage (U_n): 24 Vac/dc; 50...60 Hz

Power consumption AC: < 5 VA

Power consumption DC: < 4 W

Electrical ratings: 230/240 Vac

6 A general use

C300 pilot duty

Notes:

- Use 60 or 75°C copper (Cu) conductor and wire size No. 30-12 AWG, stranded or solid.

- The terminal tightening torque of 5-7 lb in.

- Only for 24 Vac/dc versions: supply from remote Class 2 source or limited voltage limited energy.



Safety module CS AR-40 / CS AR-41

Pin assignment

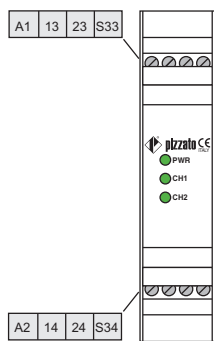

Internal block diagram

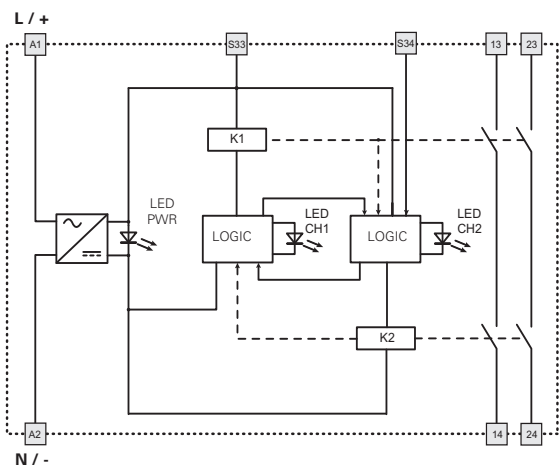

Input configuration

Emergency stop circuits
One channel input configuration with manual start

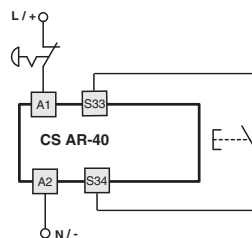

The diagram does not show the exact position of the terminals in the product

Automatic start

With regard to the indicated diagram, bridge the start button between S33 and S34 in order to activate the automatic start module.

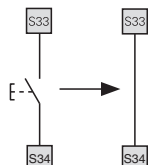

Monitored start

Use module CS AR-41 with the circuit diagrams for manual start.

Movable guard monitoring

The safety module can monitor emergency stop circuits and control circuits for movable guards. Replace the emergency stop contacts with the switch contacts.

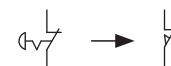

Function diagrams

1-channel configuration with automatic start (CS AR-40 only)

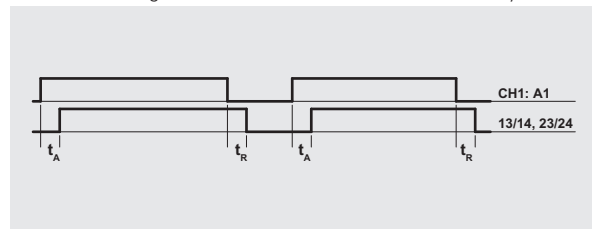

1-channel configuration with manual start (CS AR-40 only)

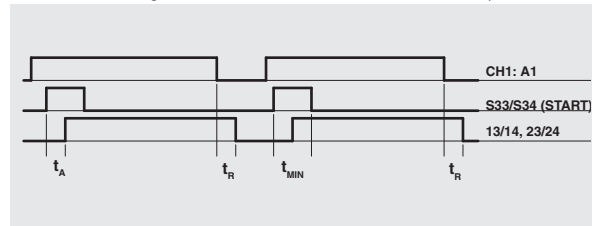

1-channel configuration with monitored start (CS AR-41 only)

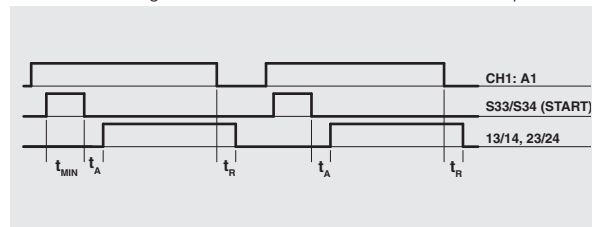

Legend:
 t_{MIN} : Min. duration of start impulse
 t_A : response time
 t_R : release time in absence of power supply