

METRON MEASURING LIGHT CURTAIN



**RS-485 SERIAL
LINE MANAGEMENT**



www.reer.it

METRON MEASURING LIGHT CURTAIN

RS-485 SERIAL LINE MANAGEMENT

SUMMARY

serial line management.....	5
Standard line mode	5
Without control checksum	5
With control checksum.....	6
Continuous reporting.....	7
Periodical reporting	8
Reporting on request.....	8
Status change reporting.....	8
Input-related reporting	8
Slave line mode	8
No node	9
Reset software COMMAND	11
CORRECT OPERATION.....	11
ERROR HANDLING	11
ENABLE OSSD COMMAND.....	12
CORRECT OPERATION.....	12
ERROR HANDLING	13
DISABLE OSSD COMMAND	13
CORRECT OPERATION.....	14
ERROR HANDLING	14
OSSD Stand-by COMMAND	15
CORRECT OPERATION.....	15
ERROR HANDLING	16
Start OSSD measurement command	17
CORRECT OPERATION.....	17
ERROR HANDLING	17
Stop OSSD MEASUREMENT COMMAND.....	18
CORRECT OPERATION.....	19
ERROR HANDLING	19
Start mEASUREMENT COMMAND.....	20
CORRECT OPERATION.....	20
ERROR HANDLING	21
Stop mEASUREMENT COMMAND.....	22
CORRECT OPERATION.....	22
ERROR HANDLING	22
REQUEST ACTIVE BEAM STATUS COMMAND.....	24
CORRECT OPERATION.....	24
ERROR HANDLING	25
REQUEST INSTANTANEOUS MEASUREMENTS COMMAND	26
CORRECT OPERATION.....	26
ERROR HANDLING	27
REQUEST CONFIGURATION COMMAND	27
CORRECT OPERATION.....	28
ERROR HANDLING	28
REQUEST OSSD STATUS COMMAND	29
CORRECT OPERATION.....	29
ERROR HANDLING	30



REQUEST LIGHT CURTAIN STATUS COMMAND	30
CORRECT OPERATION.....	31
ERROR HANDLING	31
With node	31
Reset software COMMAND.....	34
CORRECT OPERATION.....	34
ERROR HANDLING	34
ENABLE OSSD COMMAND	35
CORRECT OPERATION.....	35
ERROR HANDLING	36
DISABLE OSSD COMMAND	36
CORRECT OPERATION.....	37
ERROR HANDLING	37
OSSD STAND-BY COMMAND	38
CORRECT OPERATION.....	38
ERROR HANDLING	39
Start OSSD measurement command	40
CORRECT OPERATION.....	40
ERROR HANDLING	40
STOP OSSD MEASUREMENT COMMAND.....	41
CORRECT OPERATION.....	42
ERROR HANDLING	42
Start MEASUREMENT COMMAND.....	43
CORRECT OPERATION.....	43
ERROR HANDLING	44
Stop MEASUREMENT COMMAND	45
CORRECT OPERATION.....	45
ERROR HANDLING	45
REQUEST ACTIVE BEAM STATUS COMMAND.....	47
CORRECT OPERATION.....	47
ERROR HANDLING	48
REQUEST INSTANTANEOUS MEASUREMENTS COMMAND	49
CORRECT OPERATION.....	49
ERROR HANDLING	50
REQUEST CONFIGURATION COMMAND	51
CORRECT OPERATION.....	51
ERROR HANDLING	52
REQUEST OSSD STATUS COMMAND	52
CORRECT OPERATION.....	53
ERROR HANDLING	53
REQUEST LIGHT CURTAIN STATUS COMMAND	54
CORRECT OPERATION.....	54
ERROR HANDLING	54

SERIAL LINE MANAGEMENT

This handbook describes the communication protocol that must be used to ensure the correct exchange of information between METRON (Receiver) and a user-defined line server. The Receiver manages the RS-485 serial line in standard or Slave mode, depending on the system configuration.

Standard line mode

In this mode the field line is used to transmit the measurement report as defined during configuration. In this case, the line speed and parity are programmed in accordance with the parameters selected by the configurator. The transmission mode configuration, the presence or absence of a separator and the measurements selected when generating the report all produce differently-formatted messages, as illustrated in the examples below.

Without control checksum

In this case, the data checksum field is false.

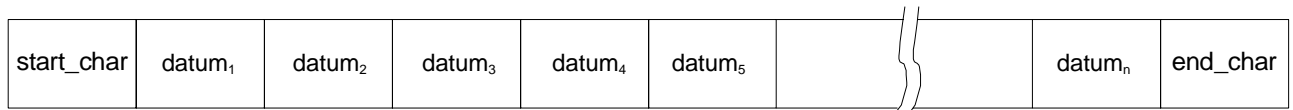

Figure 1: binary mode without separator

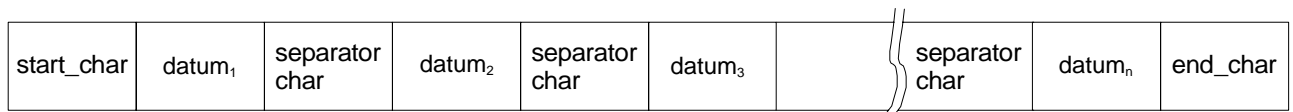

Figure 2: binary mode with separator

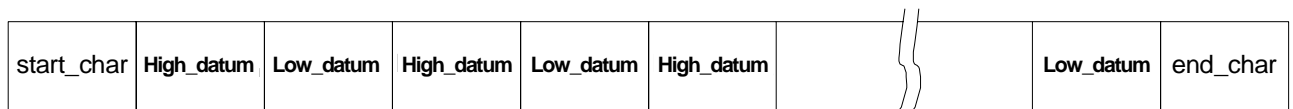

Figure 3: hex mode without separator

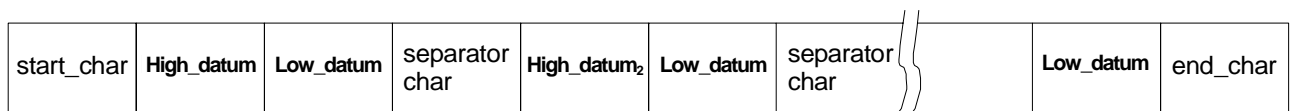

Figure 4: hex mode with separator

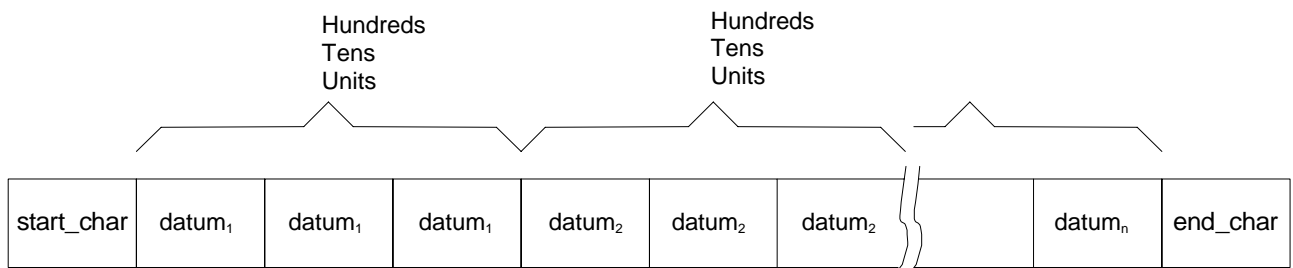

Figure 5: decimal mode without separator

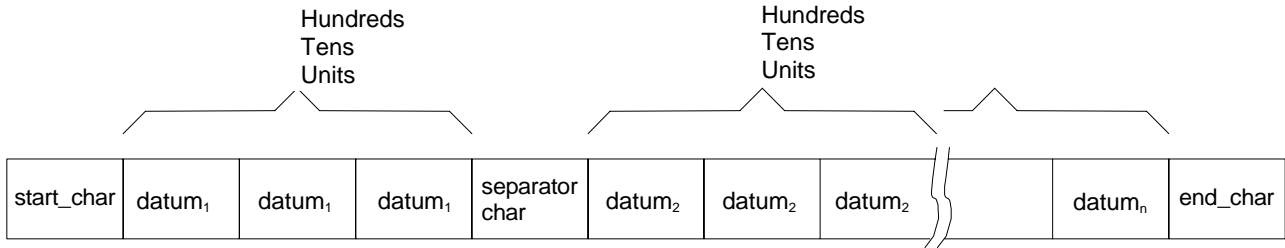

Figure 6: decimal mode with separator

With control checksum

In this case, the data checksum field is true: a character including the checksum of the data fields is added in the transmission message. The checksum is calculated as 1's complement of the sum of the bytes of the data fields only.

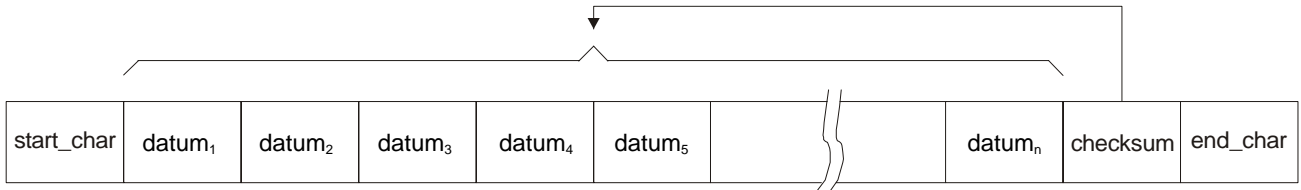

Figure 7: binary mode with checksum without separator

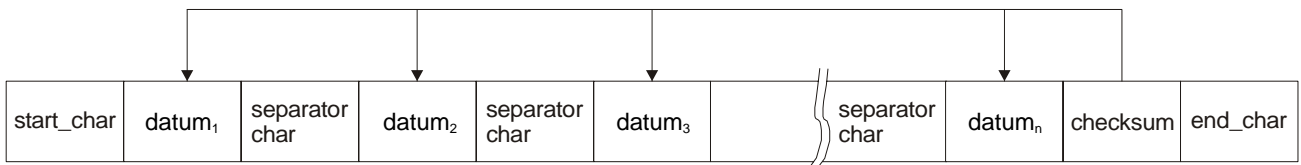

Figure 8: binary mode with checksum and separator

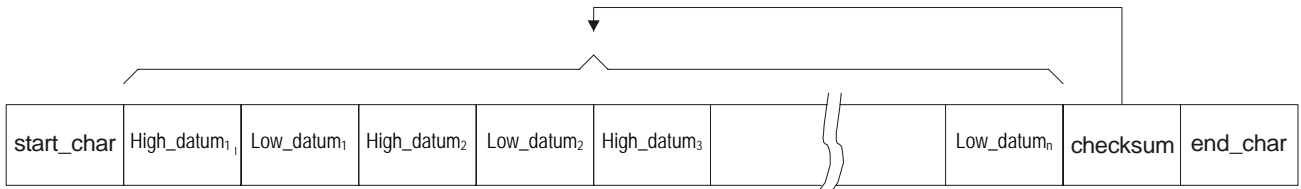

Figure 9: hex mode with checksum without separator

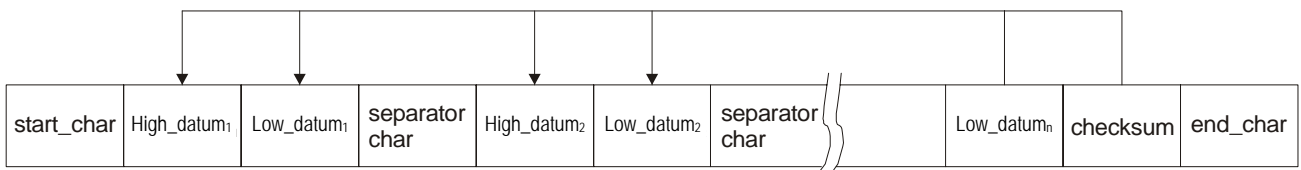

Figure 10: hex mode with checksum and separator

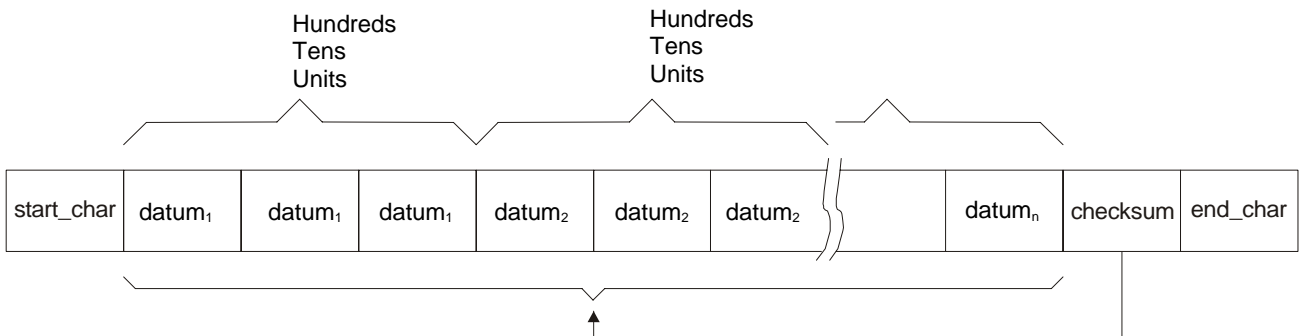

Figure 11: decimal mode with checksum without separator

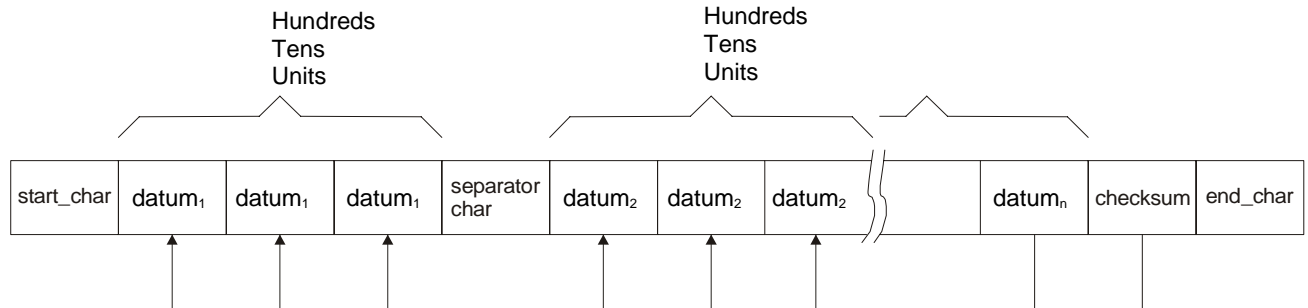

Figure 12: decimal mode with checksum and separator

The Receiver transmits the entire message using the configured mode. The total time required to send the message is shown in Equation 1 if parity is enabled, or in Equation 2 if parity is disabled, where the length of the message, expressed in the number of bytes, is shown in Table 1.

$$t_{send} = \frac{Length * 11}{Baud * 10^{-3}} + 1 \text{ ms} \quad t_{send} = \frac{Length * 10}{Baud * 10^{-3}} + 1 \text{ ms}$$

Equation 1 **Equation 2**

Length of message ¹	Separator	Mode
$data_number + 2$	No separator	binary
$2 * data_number + 1$	With separator	
$2 * data_number + 2$	No separator	hex
$3 * data_number + 1$	With separator	
$3 * data_number + 2$	No separator	decimal
$4 * data_number + 1$	With separator	

Table 1: length of message

The number_data depends on which and how many data are selected by the configurator to generate the report. Equation 1 introduces a fixed delay of 1 ms: when it has sent a complete message, the Receiver always includes a fixed delay of 1 ms to allow the Host computer to transfer the message to be interpreted. The field line can use different measurement reporting modes, which are selected by the configurator in the “reporting_mode” field. Please see the METRON use and maintenance handbook (code 8540639, “METRON configuration with standard RS-485 serial line” section).

Continuous reporting

In this mode, the Receiver prepares a report message at each scanning cycle and verifies the completion of transmission of the previous message. If complete, it starts transmitting the new message, otherwise it eliminates it.

¹ The length of the message calculated in this way must be increased by 1 if the control checksum is present.

Periodical reporting

In this mode, the Receiver prepares a report message when the configurator-defined transmission period has elapsed. Possible periods are listed below.

- 50ms
- 100ms
- 250ms
- 500ms
- 750ms
- 1s
- 1.25s
- 1.5s
- 2s
- 3s

Reporting on request

In this mode, the Receiver prepares a report message when the Host computer sends a request character the same as that defined by the configurator.

Status change reporting

In this mode, at each scanning cycle the Receiver verifies the completion of transmission of the previous message. If complete, it checks whether in the meantime there has been any change in beam status: if a change is present, it prepares and starts transmitting a report message. If there have not been any changes, nothing is sent.

Input-related reporting

In this mode, the Receiver uses the input signal as configured in the “*Input_type*” field. The use of the input signal is described below.

Input configuration	operation
No function	The input is ignored and the field line behaves exactly as for continuous reporting.
Enable line	When the input is 24VDC, the field line behaves exactly as for continuous reporting; if the input is 0VDC, the field line is disabled.
Enable all	
Start/Stop line	Monitoring of the only enabled “reporting_measure” field starts on the leading edge of the external signal, with the maximum value obtained always being stored. The measurement function stops on the trailing edge of the input signal and for three consecutive times the field line sends a message containing the maximum value that was measured.
Start/Stop all	
Line stand-by	When the input is 0VDC, the field line behaves exactly as for continuous reporting. When the input is 24VDC, the field line again behaves as for continuous reporting, but the message that is sent is not composed each time. Instead the last message that was sent is always maintained.
All stand-by	

Slave line mode

In this mode, the field line is used to query the Receiver, which always acts as an RS-485 serial line Slave. The Slave line mode has a fixed configuration:

Speed: 19200 baud
 Parity: even
 Mode: binary

The RS-485 line acts as Slave and the Receiver only responds to messages sent from a host computer of the two-way serial line. The Receiver processes the message received, if available, at each light curtain scanning cycle. As a result of processing it starts transmitting the reply message. Consequently, the delay between the moment the Host starts to transmit a message and the moment the Receiver starts transmitting the reply is shown by Equation 3.

$$t_{late} = n_{byte} * 11 * 0.05208 \text{ ms} + \frac{t_{reply}}{2}$$

Equation 3

Please see the METRON use and maintenance handbook (code 8540639, "**Technical features**" section) for the $t_{response}$. The following sections describe the desired protocols.

No node

Figure 13 below illustrates the connection of the Receiver to a Host with the node selection deactivated. The measuring light curtain has its own RS-485 line termination resistance; a similar resistance must be provided on the host terminal or on a point close thereto. In this case, the structure of the message the Host must send to the Receiver is that shown in Figure 14. Information is always exchanged in question-answer mode: the Host sends a data packet to the Receiver (Slave) which responds with another data packet to the Host.

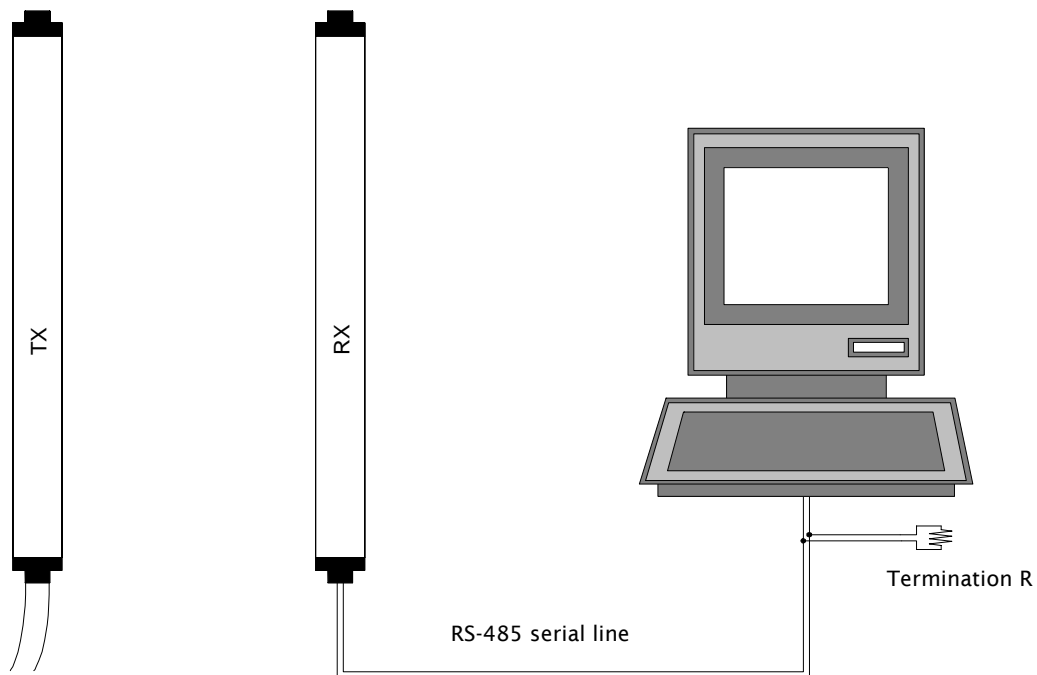

Figure 13: connection of Receiver to a Host

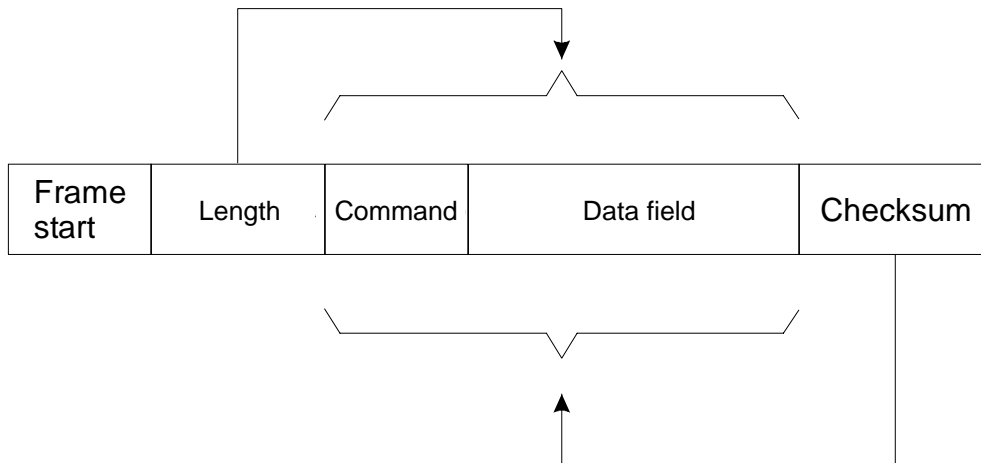

Figure 14: structure of message from Host to Receiver

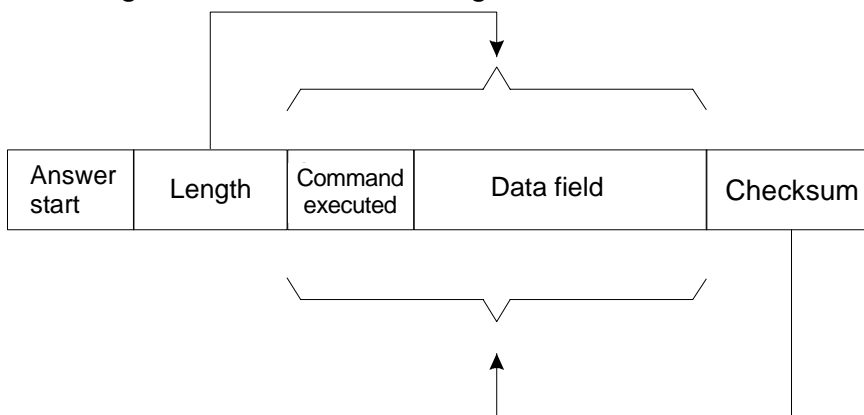

Figure 15: reply from Receiver to Host

The message in Figure 14 contains the following fields:

Frame start: this is the message start character

Length: a byte that defines the length, comprising the command and data field. **For currently defined messages, the maximum value of the length field is 6.**

Command: a byte that contains the command sent from Host to Receiver

Data field: a field, not necessarily present, containing auxiliary data associated with the command being executed

Checksum: a byte that is the complement to 1 of the sum of the bytes in the Command and Data fields

As mentioned above, the Receiver replies to messages from the Host computer. Since the line is configured with the parity bit enabled, parity occurs upon receiving each byte. In the event of an error, the message is rejected and considered incorrect: in this case there is no reply from the Receiver. Below is the list of commands available and their functional details.

Command	Use
Reset software	The Host can use this command to generate a Reset Receiver software.
Enable OSSD	The Host can use this command to enable the previously disabled OSSD functions.
Disable OSSD	The Host can use this command to disable all the previously enabled OSSD functions.
OSSD Stand-by	The Host can use this command to put all the previously enabled OSSD functions in Stand-by
Start OSSD measurement	The Host can use this command to start a Start/Stop-type measurement phase on all the enabled OSSD functions.
Stop OSSD measurement	The Host can use this command to terminate a Start/Stop-type measurement phase on all the enabled OSSD functions

Command	Use
Start measurement	The Host can use this command to start a Start/Stop-type measurement phase specifying a measurement field at will
Stop measurement	The Host can use this command to end a previously activated Start/Stop-type measurement phase
Request active beam status	The Host can use this command to request the status of a single beam or of all the active beams of the light curtain
Request instantaneous measurements	The Host can use this command to request the current value of one or more available measurements
Request configuration	The Host can use this command to request measuring light curtain configuration
Request OSSD status	The Host can use this command to request the current status of the two OSSDs
Request light curtain status	The Host can use this command to request the current status of the light curtain

RESET SOFTWARE COMMAND

The Host can use this command to generate a Reset Receiver software. The Host sends the following message:

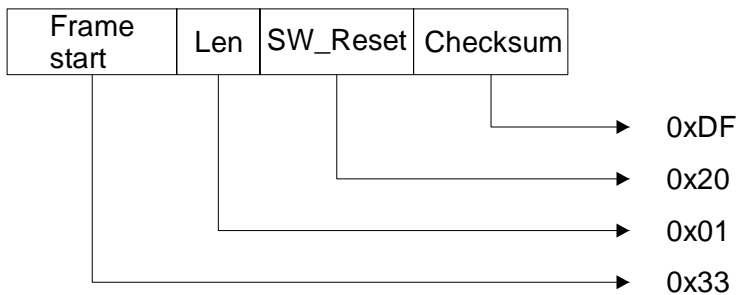

CORRECT OPERATION

The Receiver does not send a reply message and executes a system reset. A character is shown on the Display. Please see the METRON use and maintenance handbook (code 8540639, "Signals" section).

ERROR HANDLING

1. If the message received contains a corrupt checksum or the length field contains a value exceeding the maximum value allowed, the Receiver replies as follows:

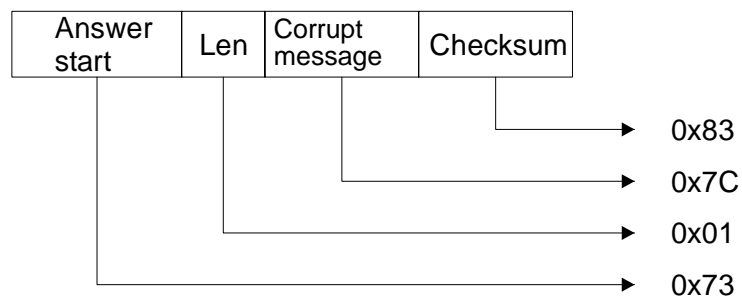

and the reset software command is not executed.

2. If the message received is correct, but the length is not, the Receiver replies as follows:

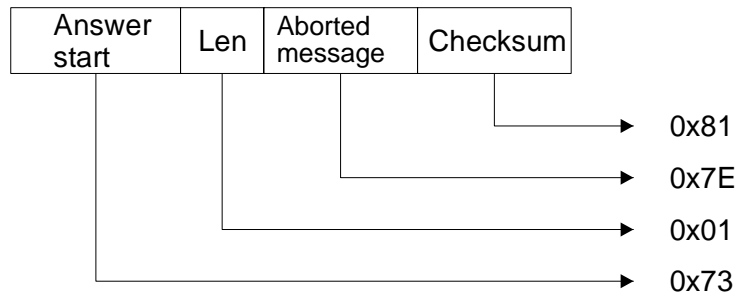

and the reset software command is not executed.

ENABLE OSSD COMMAND.

The Host can use this command to enable the previously disabled OSSD functions. The Host must send the following message:

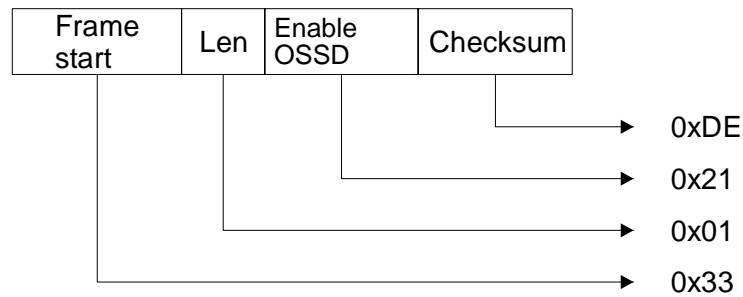

CORRECT OPERATION

The Receiver replies with the following message:

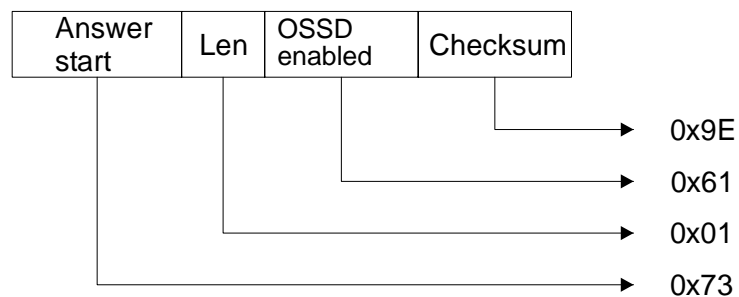

and executes the enable OSSD command.

ERROR HANDLING

1. If the message received contains a corrupt checksum or the length field contains a value exceeding the maximum value allowed, the Receiver replies as follows:

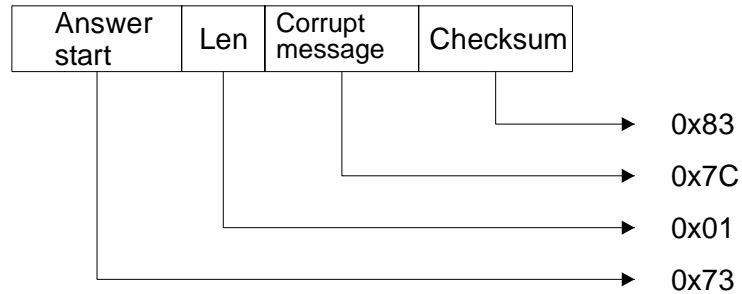

and the enable OSSD command is not executed.

2. If the message received is correct, but the “input_type” parameter is not configured as *No_function* or the length is not correct, the Receiver replies as follows:

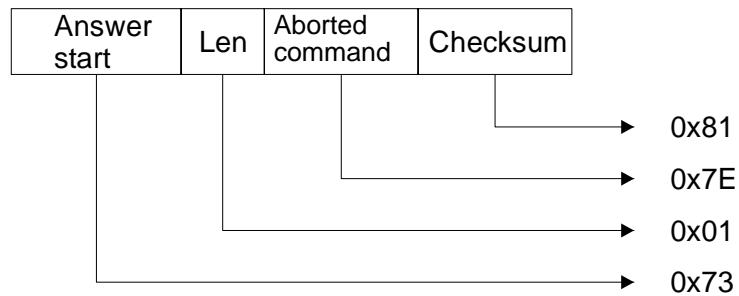

and the enable OSSD command is not executed.

DISABLE OSSD COMMAND

The Host can use this command to disable all the previously enabled OSSD functions. The Host must send the message:

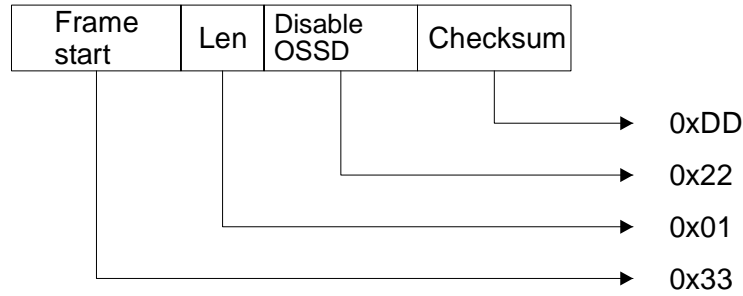

CORRECT OPERATION

The Receiver replies with the following message:

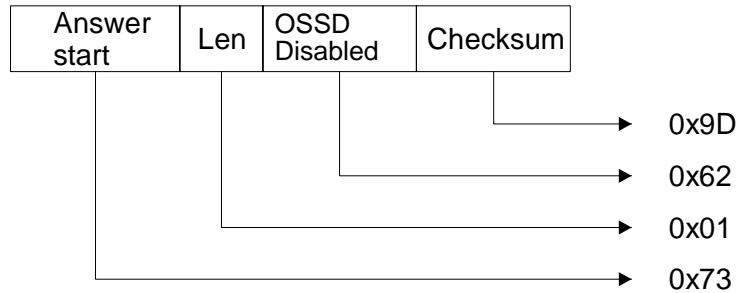

and executes the disable OSSD command.

ERROR HANDLING

1. If the message received contains a corrupt checksum or the length field contains a value exceeding the maximum value allowed, the Receiver replies as follows:

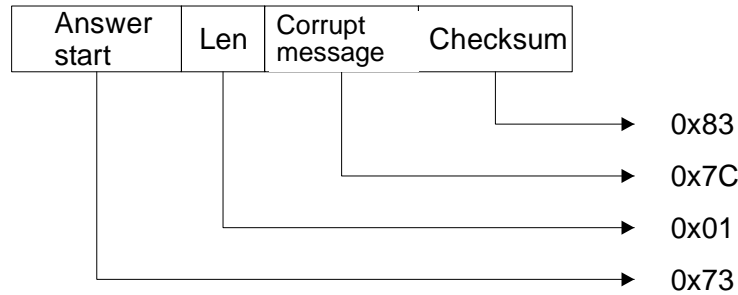

and the disable OSSD command is not executed.

2. If the message received is correct, but the “input_type” parameter is not configured as *No_function* or the length is not correct, the Receiver replies as follows:

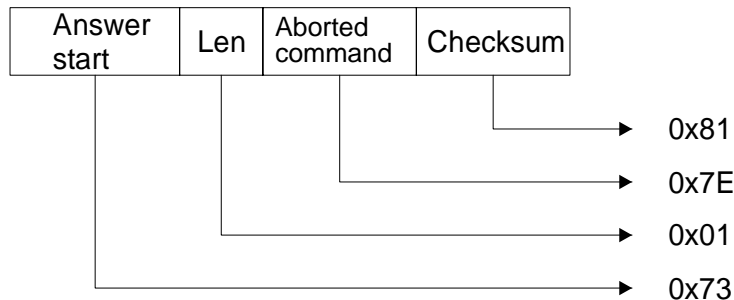

and the disable OSSD command is not executed.

3. If the message received is correct, but the OSSD status was not enabled, the Receiver replies as follows:

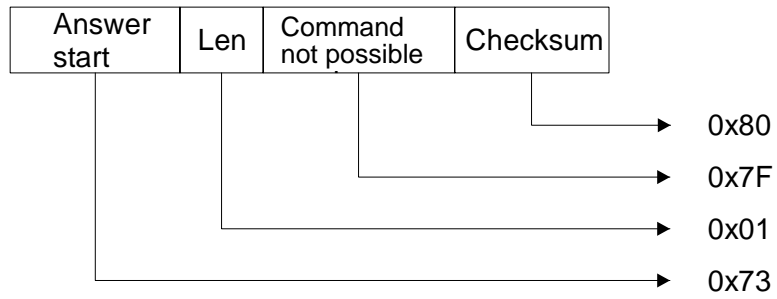

and the disable OSSD command is not executed.

OSSD STAND-BY COMMAND

The Host can use this command to put all the previously enabled OSSD functions in Stand-by. The Host sends the message:

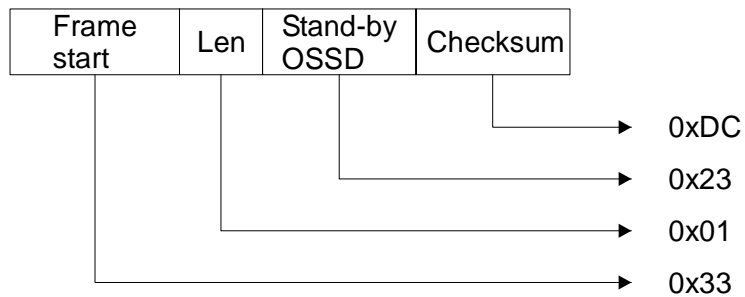

CORRECT OPERATION

The Receiver replies with the following message:

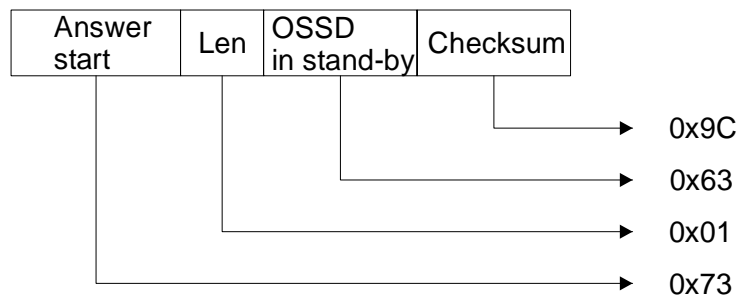

and executes the all OSSDs in stand-by command.

ERROR HANDLING

1. If the message received contains a corrupt checksum or the length field contains a value exceeding the maximum value allowed, the Receiver replies as follows:

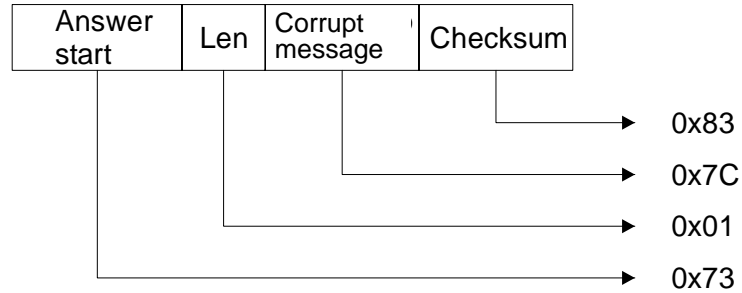

and the OSSD stand-by command is not executed.

2. If the message received is correct, but the “input_type” parameter is not configured as *No_function* or the length is not correct, the Receiver replies as follows:

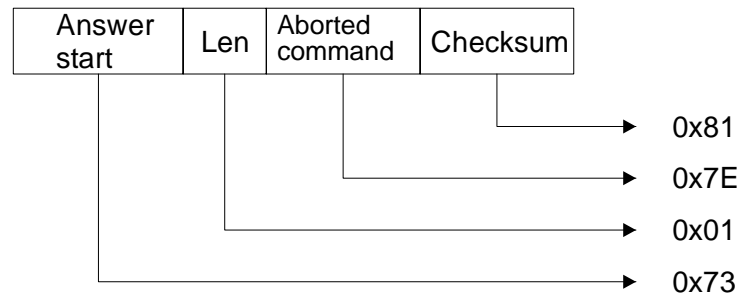

and the OSSD stand-by command is not executed.

3. If the message received is correct, but the OSSD status was not enabled, the Receiver replies as follows:

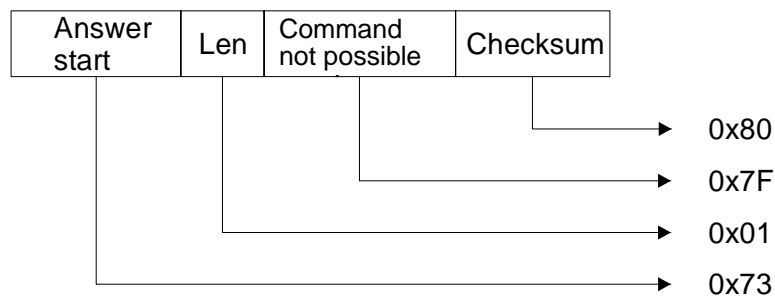

and the OSSD stand-by command is not executed.

START OSSD MEASUREMENT COMMAND

The Host can use this command to start a Start/Stop-type measurement phase on all the enabled OSSD functions. The Host sends the message:

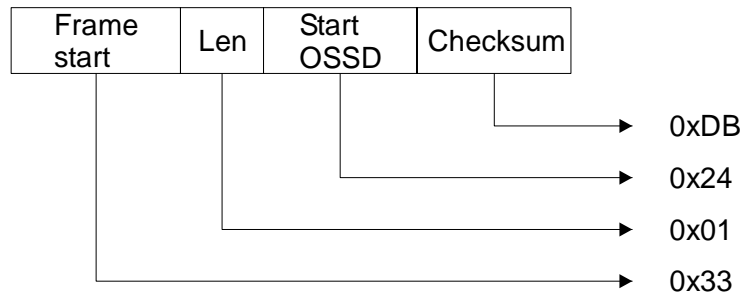

CORRECT OPERATION

The Receiver replies with the following message:

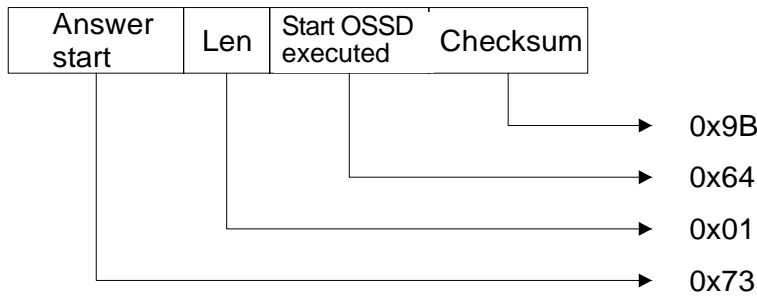

and starts the Start/Stop measurement procedure on all the enabled OSSD functions.

ERROR HANDLING

1. If the message received contains a corrupt checksum or the length field contains a value exceeding the maximum value allowed, the Receiver replies as follows:

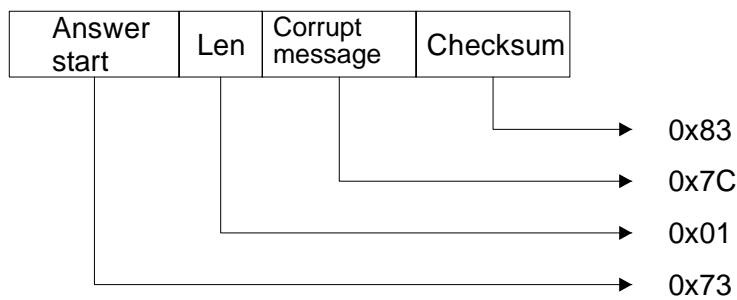

and the Start OSSD command is not executed.

2. If the message received is correct, but the “input_type” parameter is not configured as *No_function* or the length is not correct, the Receiver replies as follows:

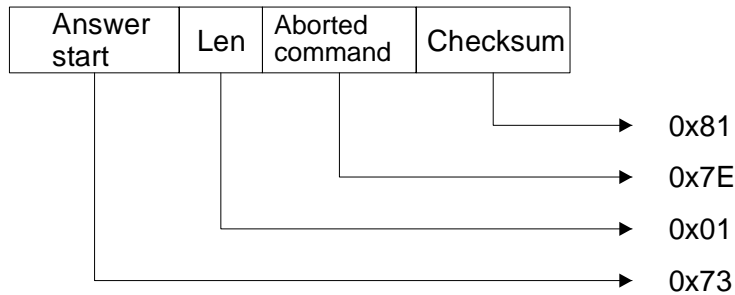

and the Start OSSD command is not executed.

3. If the message received is correct, but the OSSD status was not enabled, the Receiver replies as follows:

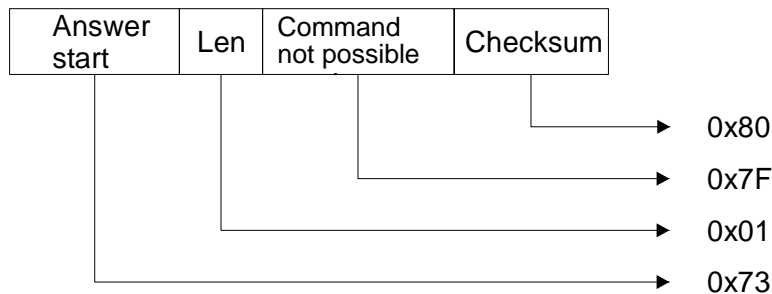

and the Start OSSD command is not executed.

STOP OSSD MEASUREMENT COMMAND

The Host can use this command to end a Start/Stop-type measurement phase on all the enabled OSSD functions. The Host sends the message:

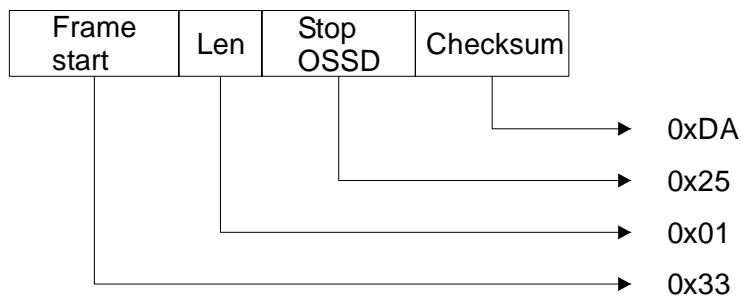

CORRECT OPERATION

The Receiver replies with the following message:

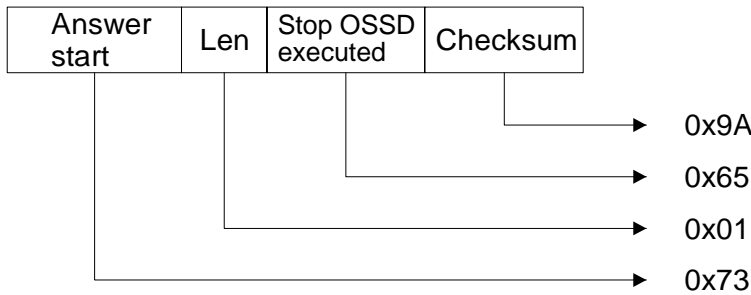

and ends the Start/stop measurement procedure on all the enabled OSSD functions, generating the OSSDs.

ERROR HANDLING

1. If the message received contains a corrupt checksum or the length field contains a value exceeding the maximum value allowed, the Receiver replies as follows:

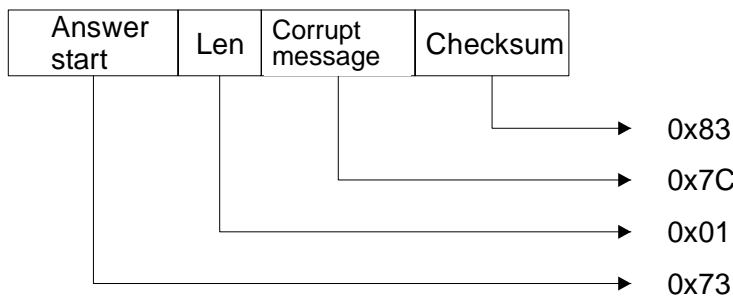

and the Stop OSSD command is not executed.

2. If the message received is correct, but the “input_type” parameter is not configured as *No_function* or the length is not correct, the Receiver replies as follows:

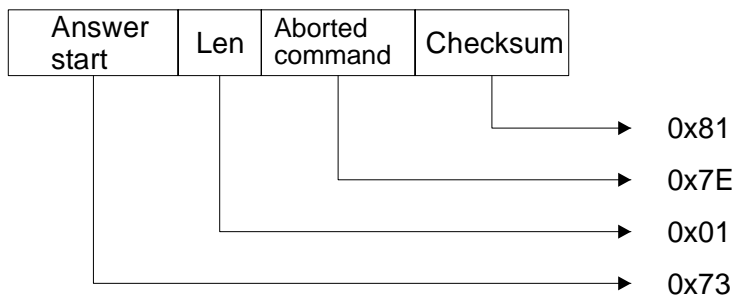

and the Stop OSSD command is not executed.

3. If the message received is correct, but the previous message was not to Start, the Receiver replies as follows:

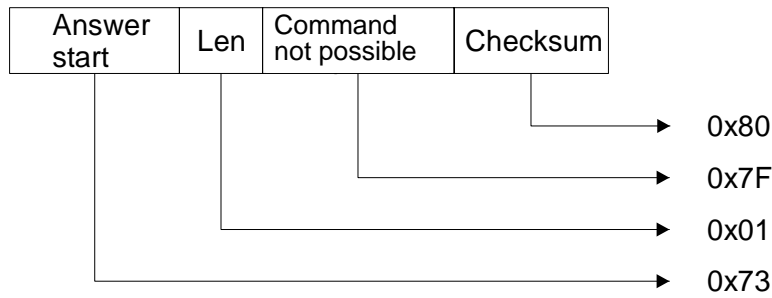

and the Stop OSSD command is not executed.

START MEASUREMENT COMMAND

The Host can use this command to start a Start/Stop-type measurement phase specifying a measurement field at will. The Host sends the message:

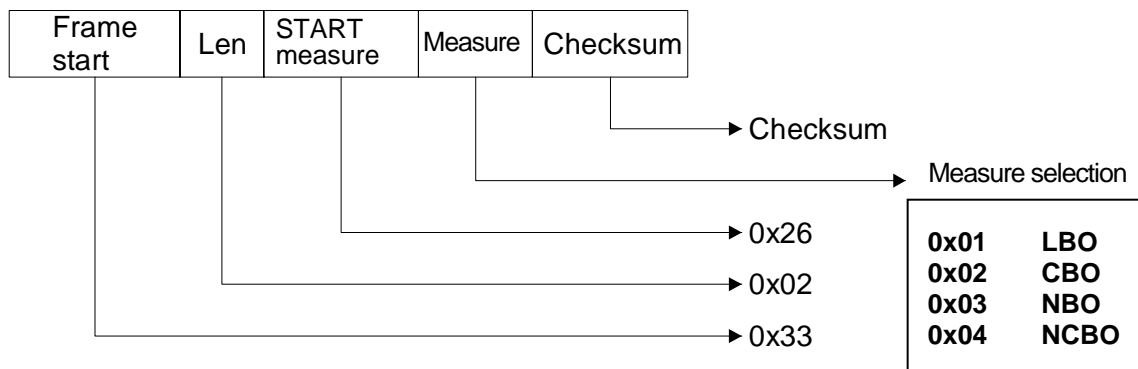

CORRECT OPERATION

The Receiver replies with the following message:

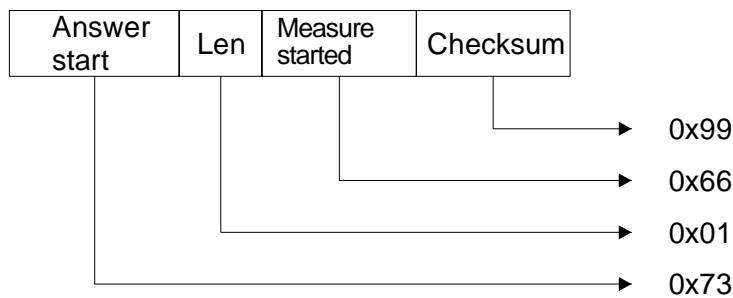

and starts the Start/Stop measurement procedure on the desired field.

ERROR HANDLING

1. If the message received contains a corrupt checksum or the length field contains a value exceeding the maximum value allowed, the Receiver replies as follows:

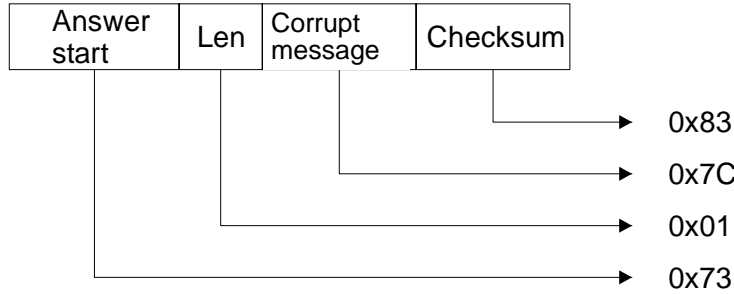

and the Start measurement command is not executed.

2. If the message received contains a length other than 2 (the measurement is not specified or there is more than one) or the measurement field value is not among those allowed, the Receiver replies as follows:

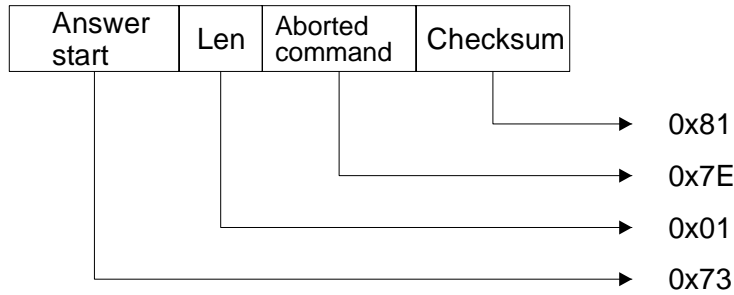

and the Start measurement command is not executed.

3. If the message received is correct, but the synchronism is missing, the Receiver replies as follows:

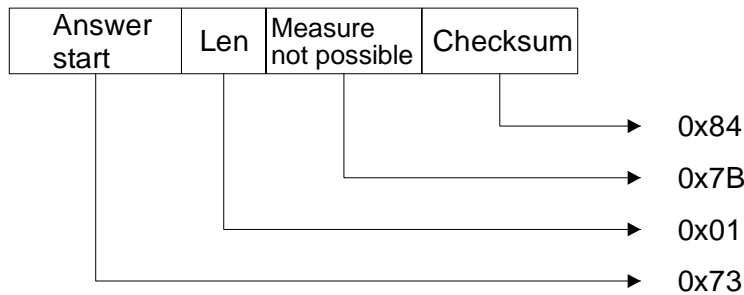

and the Start measurement command is not executed.

STOP MEASUREMENT COMMAND

The Host can use this command to end a previously activated Start/Stop-type measurement phase. The Host sends the message:

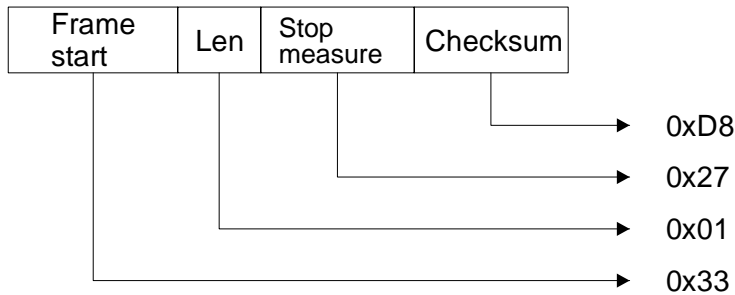
CORRECT OPERATION

The Receiver replies with the following message:

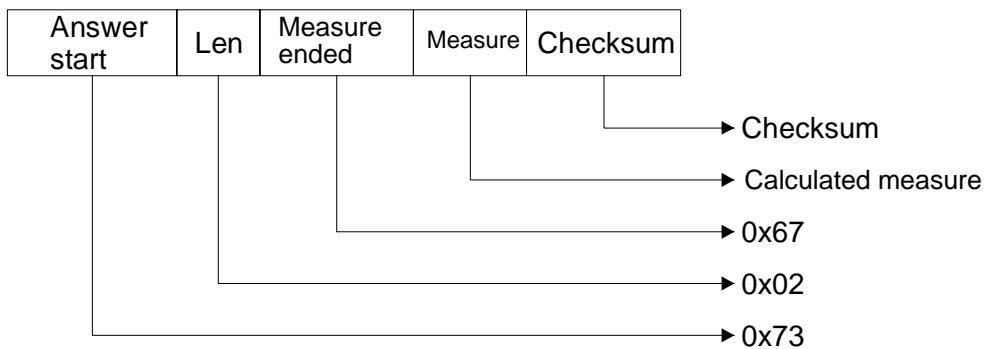

and ends the Start/Stop measurement procedure on the requested field.

ERROR HANDLING

1. If the message received contains a corrupt checksum or the length field contains a value exceeding the maximum value allowed, the Receiver replies as follows:

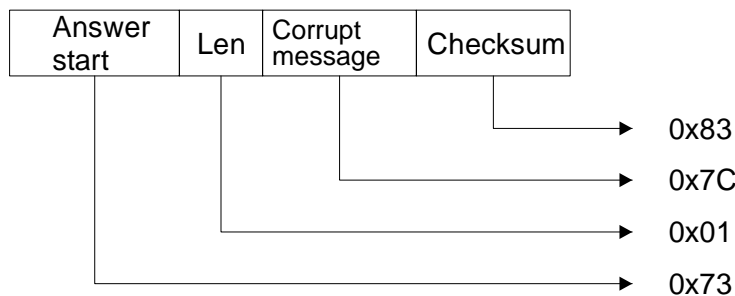

and the Stop measurement command is not executed.

2. If the message received contains a length other than 1, the Receiver replies as follows:

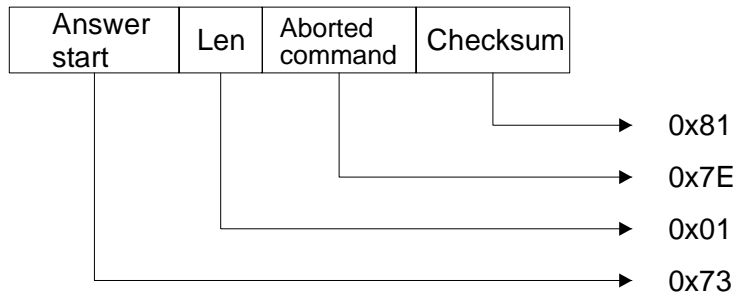

and the Stop measurement command is not executed.

3. If the message received is correct, but the synchronism is missing, the Receiver replies as follows:

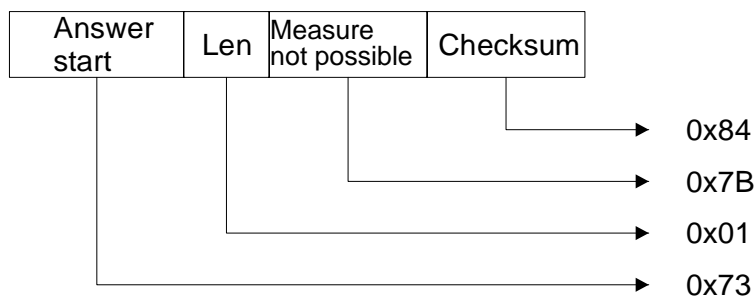

and the Stop measurement command is not executed.

4. If the message received is correct, but the previous message was not to Start measurement, the Receiver replies as follows:

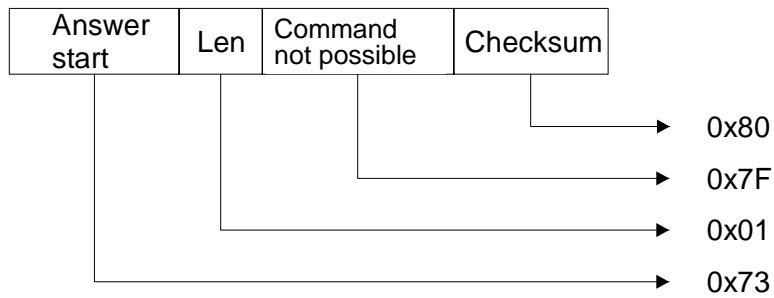

and the Stop measurement command is not executed.

REQUEST ACTIVE BEAM STATUS COMMAND

The Host can use this command to request the status of a single beam or of all the active beams of the light curtain. The Host sends one of the following messages:

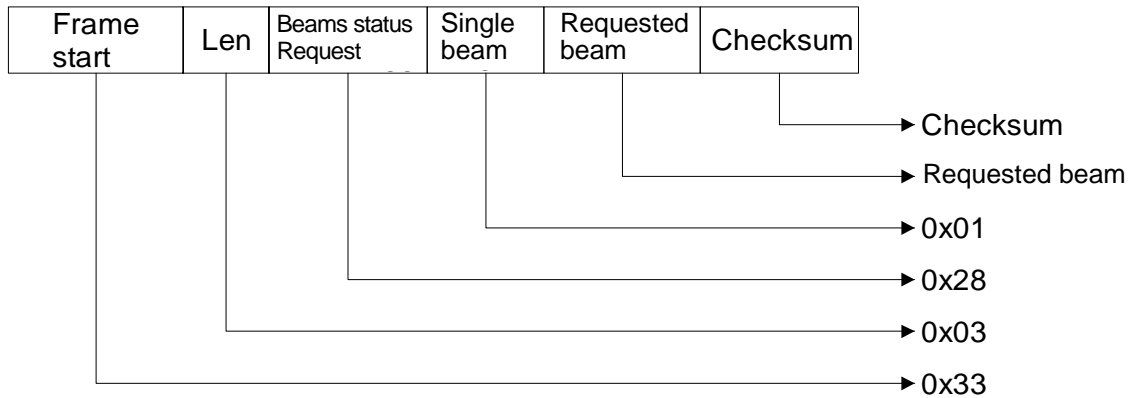

or

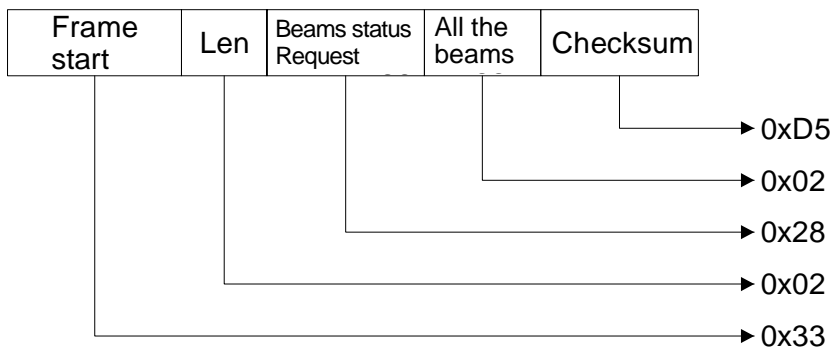

CORRECT OPERATION

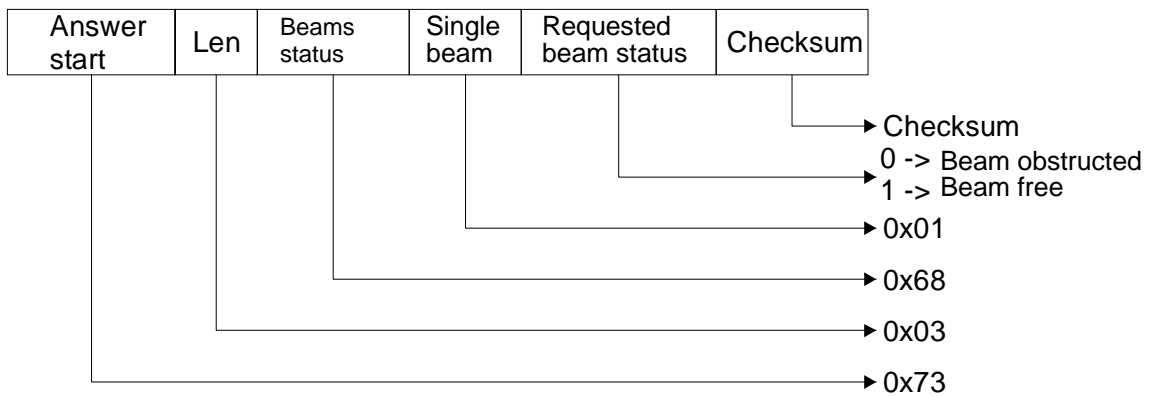
The Receiver replies with the following message:

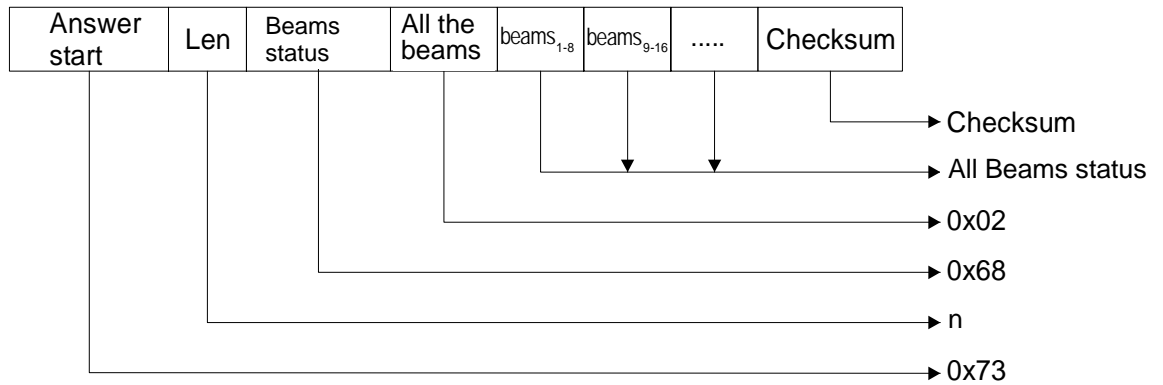

and sends the status of the requested beam.

Or:



and sends the status of all the beams. The status of each beam takes up one bit of each byte that is transmitted: e.g., a 24-beam light curtain will send 3 bytes in which each bit represents the status of each beam starting from the first; a 30-beam light curtain will send 4 bytes, with the last two bits of the last byte as X.

ERROR HANDLING

1. If the message received contains a corrupt checksum or the length field contains a value exceeding the maximum value allowed, the Receiver replies as follows:

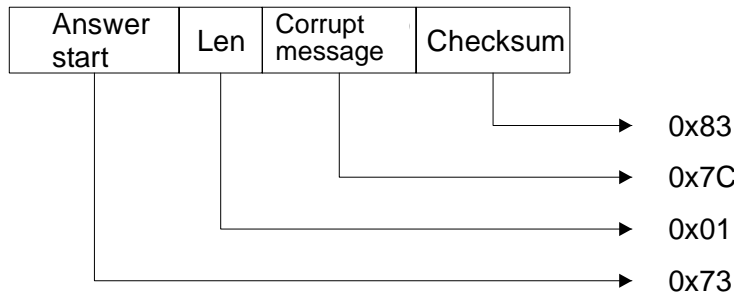

and the requested beam status is not sent.

2. If the message received contains an incorrect length or the single beam requested does not exist or the request is other than for a single beam or all beams, the Receiver replies as follows:

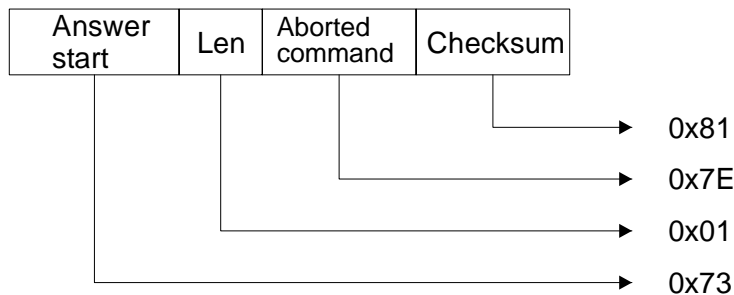

and the requested beam status is not sent.

REQUEST INSTANTANEOUS MEASUREMENTS COMMAND

The Host can use this command to request the current value of one or more available measurements. The Host sends the message:

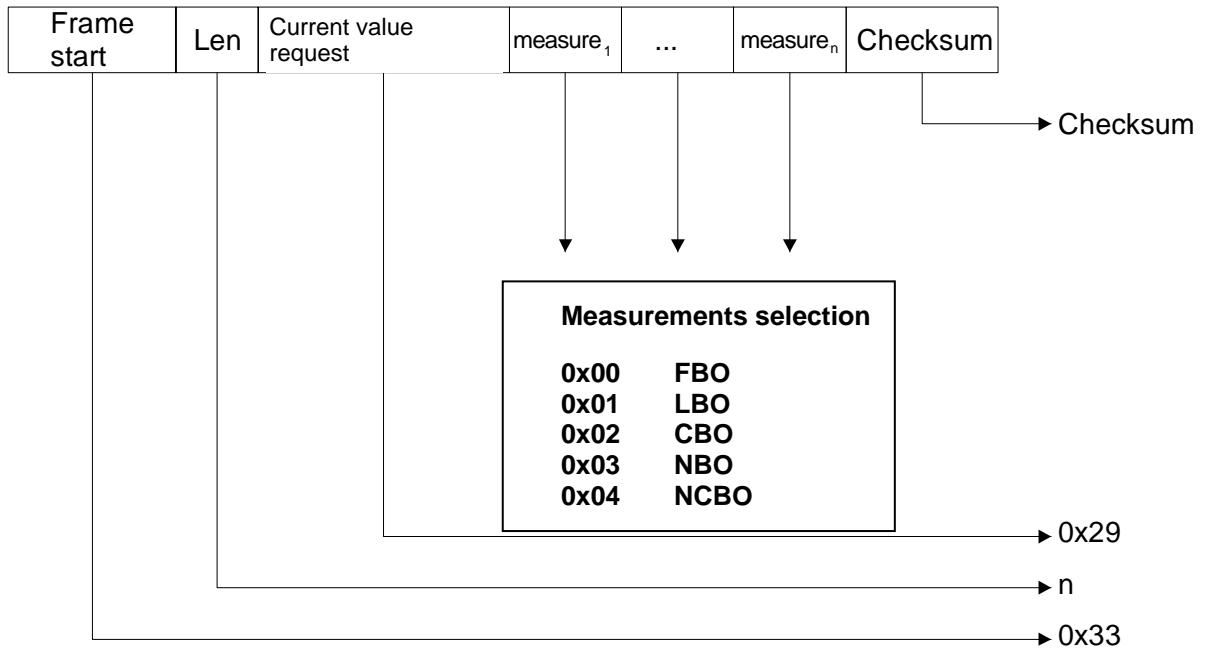
CORRECT OPERATION

The Receiver replies with the following message:

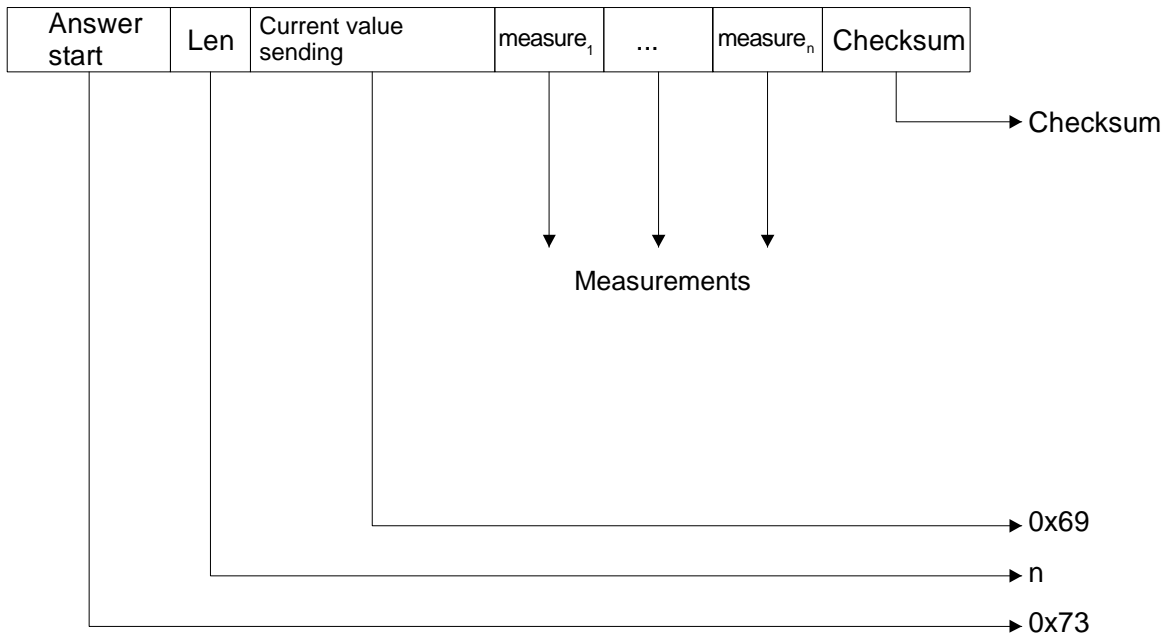

and sends the requested measurements.

ERROR HANDLING

1. If the message received contains a corrupt checksum or the length field contains a value exceeding the maximum value allowed, the Receiver replies as follows:

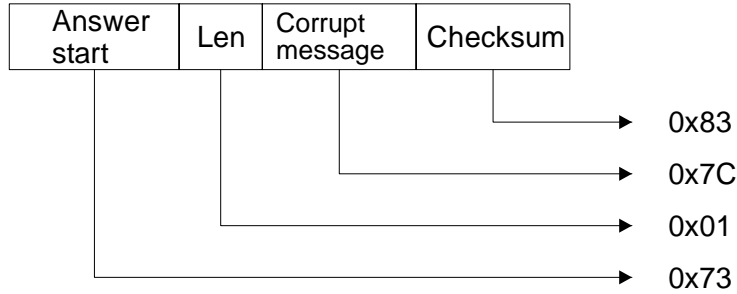

and the requested measurement is not sent.

2. If the message received contains an incorrect length or the measurement field value is not among those allowed, the Receiver replies as follows:

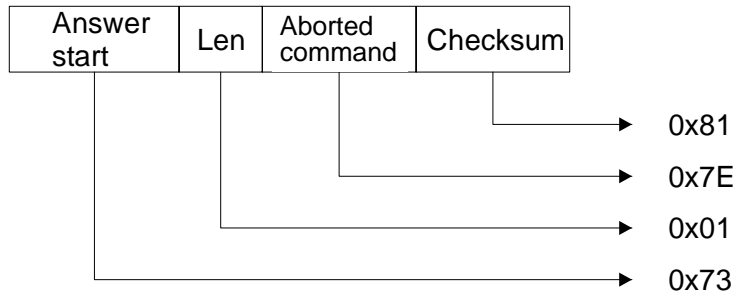

and the requested measurement is not sent.

3. If the message received is correct, but the synchronism is missing, the Receiver replies as follows:

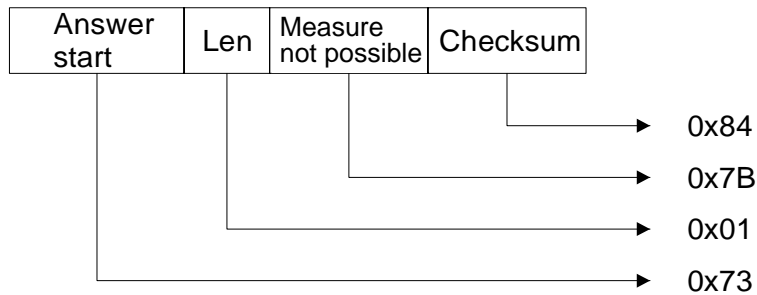

and the requested measurement is not sent.

REQUEST CONFIGURATION COMMAND

The Host can use this command to request Receiver configuration. The Host sends the message:

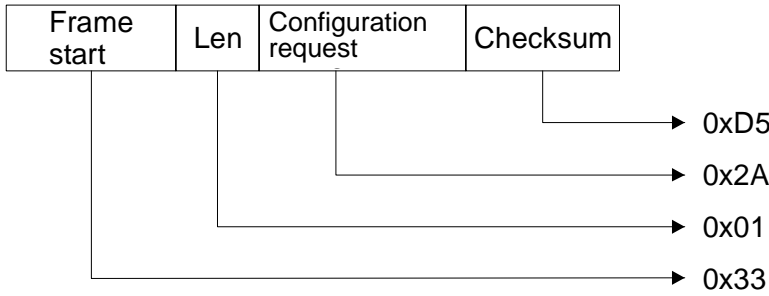

CORRECT OPERATION

The Receiver replies with the following message:

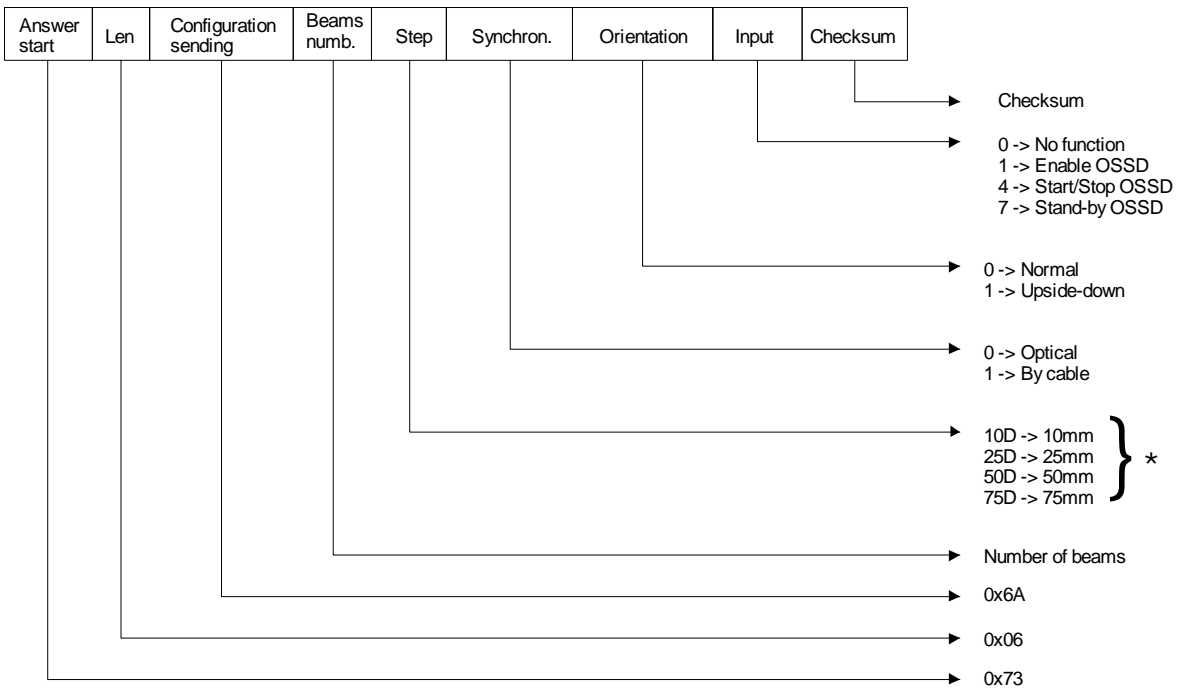

and sends the requested configuration.

* **value in decimal mode**

ERROR HANDLING

1. If the message received contains a corrupt checksum or the length field contains a value exceeding the maximum value allowed, the Receiver replies as follows:

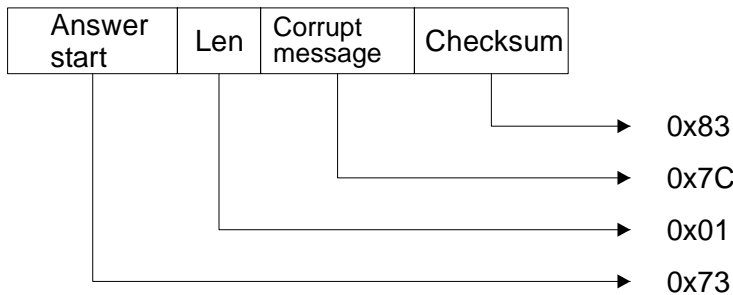

and the requested configuration is not sent.

- If the message received contains an incorrect length, the Receiver replies as follows:

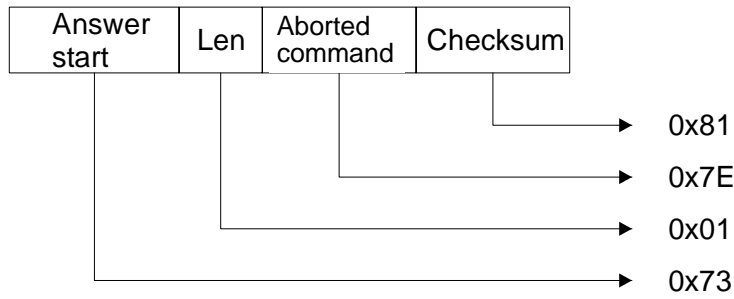

and the configuration requested is not sent.

REQUEST OSSD STATUS COMMAND

The Host can use this command to request the current status of the two OSSDs. The Host sends the message:

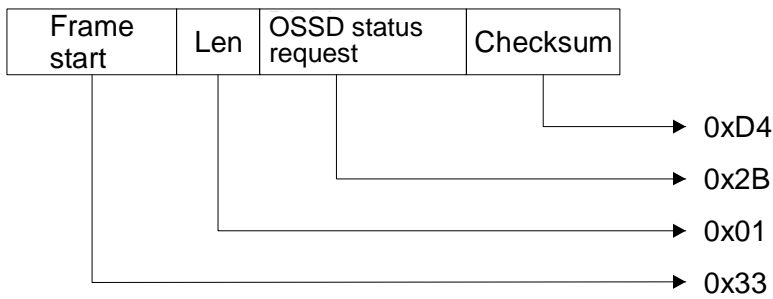

CORRECT OPERATION

The Receiver replies with the following message:

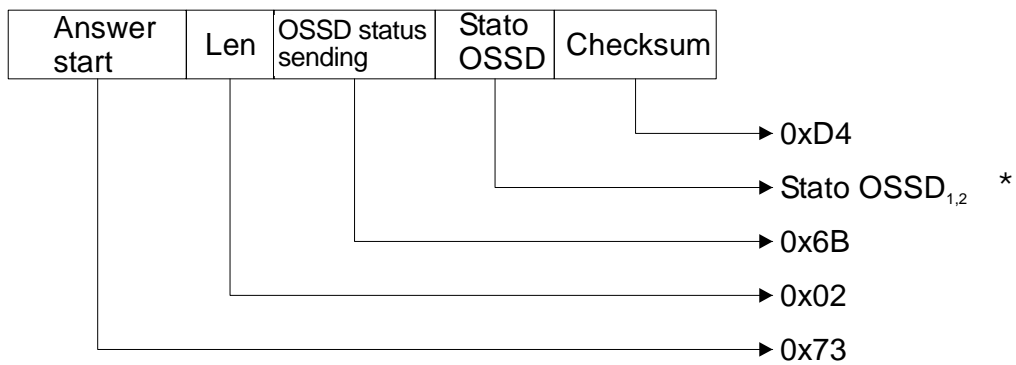

and sends the requested OSSD status.

* where 0 means OSSD in OFF status
where 1 means OSSD in ON status

ERROR HANDLING

If the message received contains a corrupt checksum or the length field contains a value exceeding the maximum value allowed, the Receiver replies as follows:

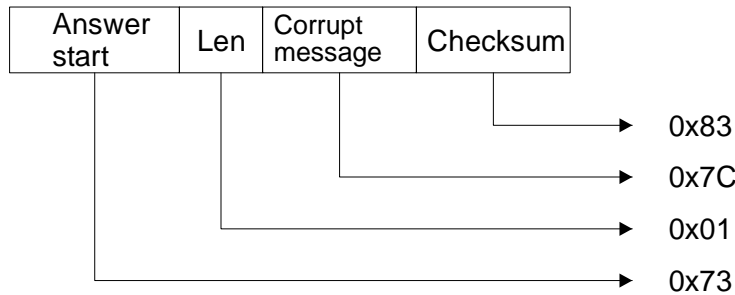

and the requested OSSD status is not sent.

If the message received contains an incorrect length, the Receiver replies as follows:

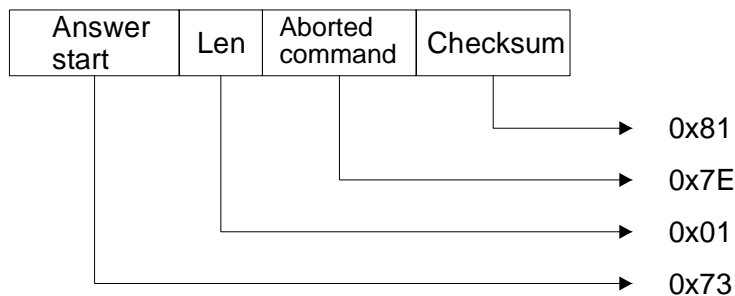

and the requested OSSD status is not sent.

REQUEST LIGHT CURTAIN STATUS COMMAND

The Host can use this command to request the current status of the Receiver. The Host sends the message:

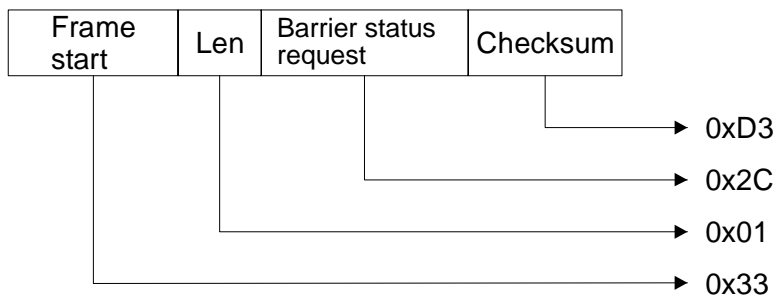

CORRECT OPERATION

The Receiver replies with the following message:

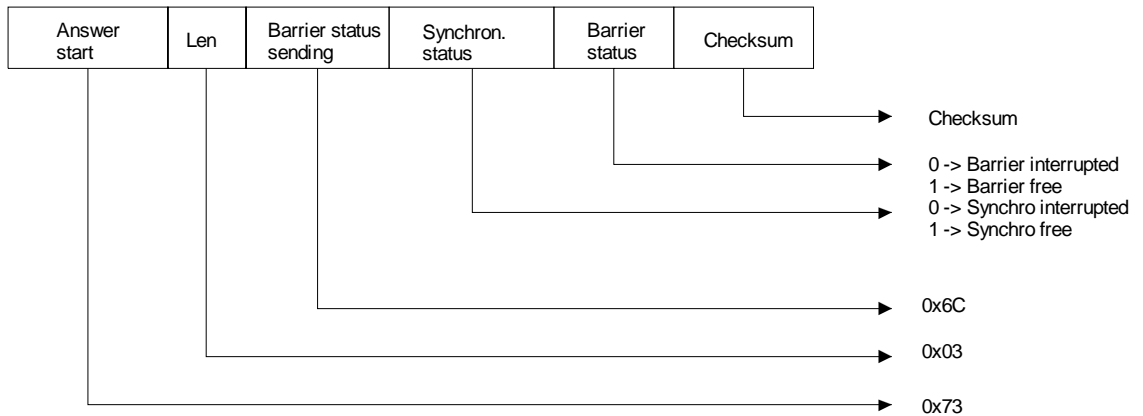

and sends the requested light curtain status.

ERROR HANDLING

1. If the message received contains a corrupt checksum or the length field contains a value exceeding the maximum value allowed, the Receiver replies as follows:

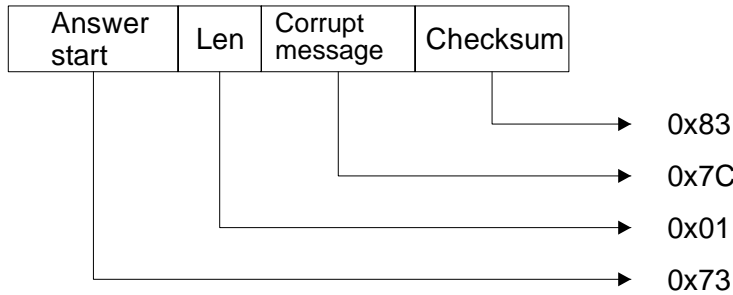

and the requested light curtain status is not sent.

2. If the message received contains an incorrect length, the Receiver replies as follows:

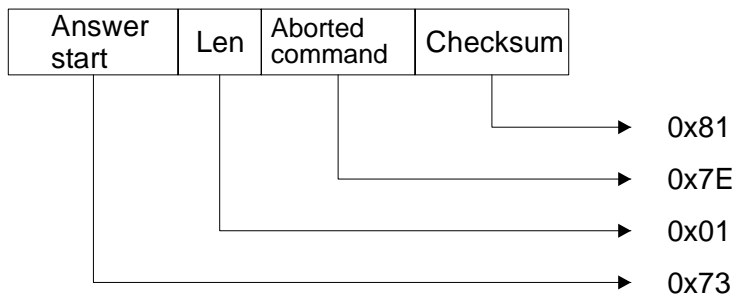

and the requested light curtain status is not sent.

With node

Figure 16 below illustrates the connection of a number of Receivers to a Host when the node selection is active. *The measuring light curtain does not have its own RS-485 line*

termination resistance; two termination resistances must be fitted at the two ends of the line.

In this case, the structure of the message that the Host must send to the Receiver is that shown in Figure 17. Information is again exchanged in question-answer mode: the Host sends a data packet to one of the Receivers which, on recognising its address, replies with another data packet to the Host. The Host can send “Broadcast” commands to all the connected Receivers: the “Broadcast” message does not envisage a reply.

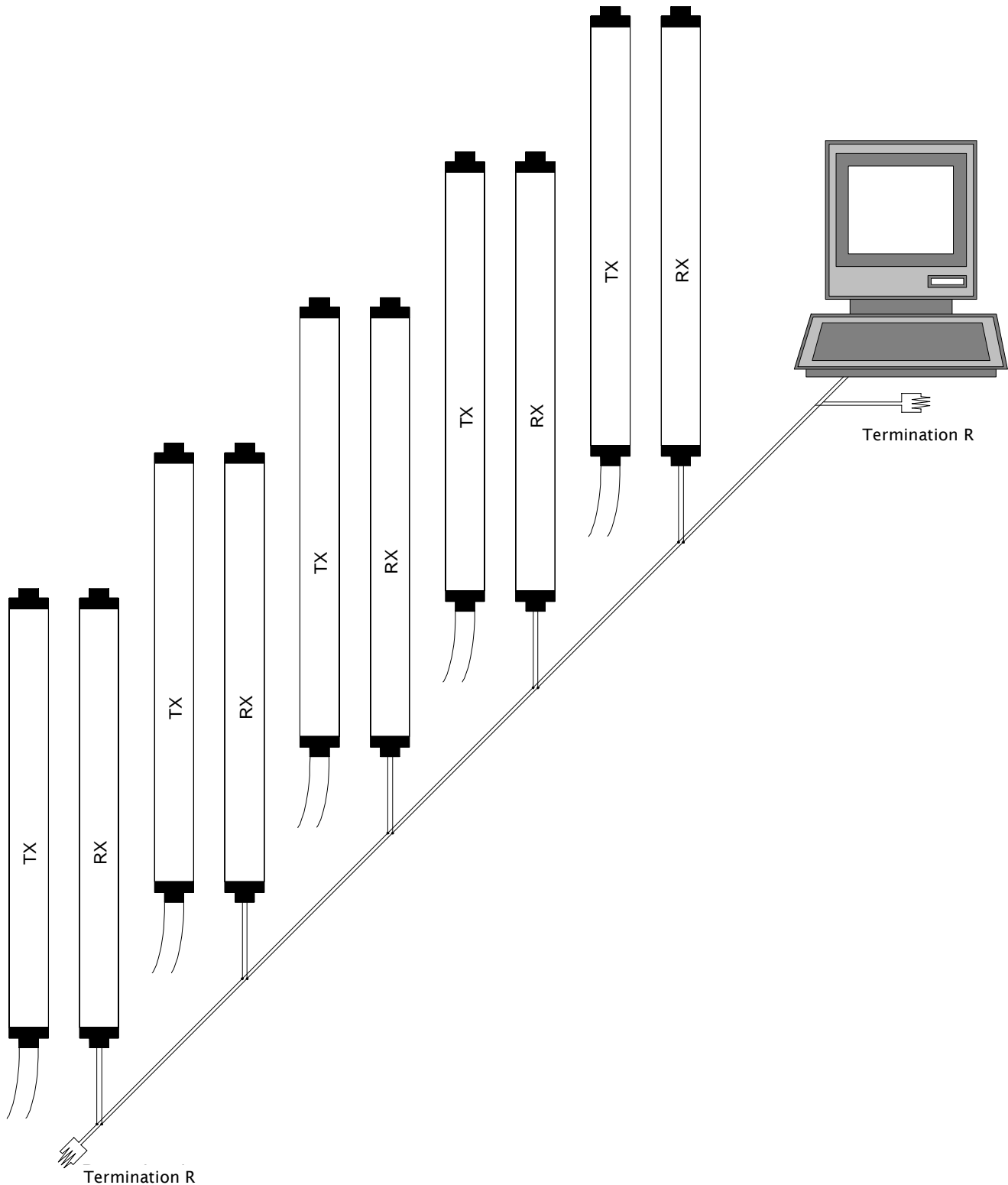

Figure 16: connection of a number of Receivers to a Host

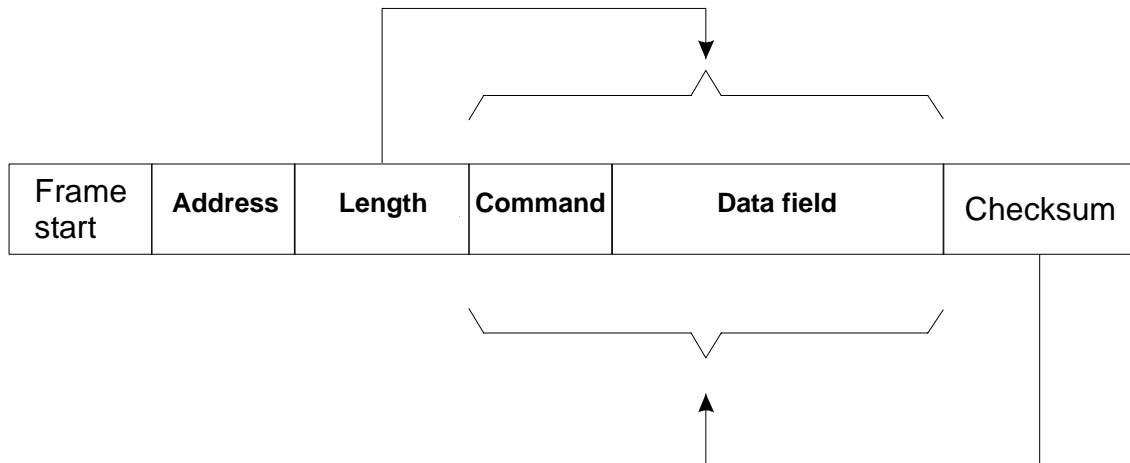

Figure 17: structure of message from Host to a node

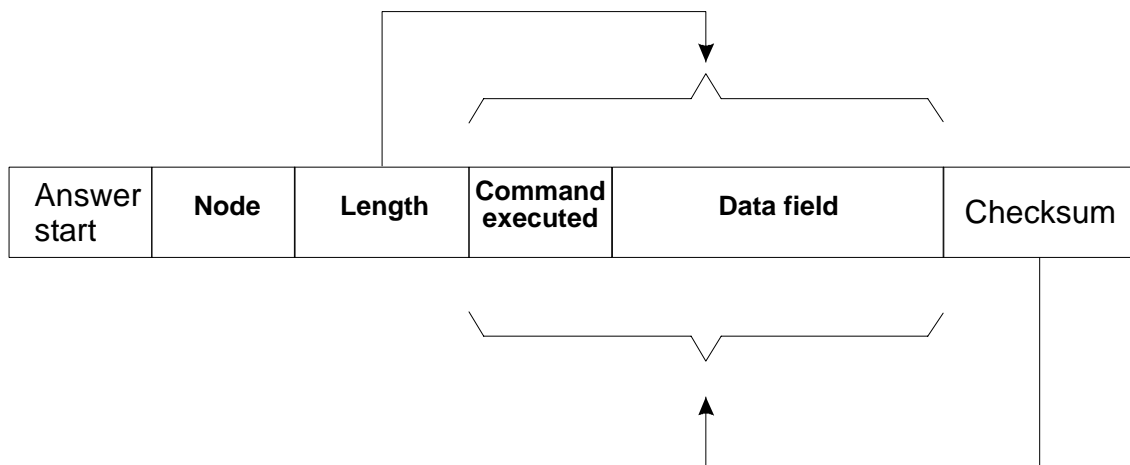

Figure 18: reply from a Receiver to Host

The message in Figure 17 contains the following fields:

- 1) Frame start: this is the message start character
- 2) Address: the address of the queried light curtain
- 3) Length: a byte that defines the length, comprising the command and data field. **For currently defined messages, the maximum value of the length field is 6.**
- 4) Command: a byte that contains the command sent from Host to Receiver
- 5) Data field: a field, not necessarily present, containing auxiliary data associated with the command being executed
- 6) Checksum: a byte that is the complement to 1 of the sum of the bytes in the Command and Data fields

As mentioned above, the Receiver replies to messages from the Host computer. Since the line is configured with the parity bit enabled, parity occurs upon receiving each byte. In the event of an error, the message is rejected and considered incorrect: in this case there is no reply from the Receiver. In the node management mode, the message that is received is only accepted in the following two cases:

If the message has the same address as the node number configured in the internal EPROM memory. In this case, the message is recognised as belonging to the node and thus managed. The reply message always contains the node number of the responding light curtain.

If the message has the “Broadcast” 255 address: in this case it is accepted **without ever generating a reply message**. A request for data and/or information with the “Broadcast” address is rejected without generating a reply.

Below is the list of commands available.

RESET SOFTWARE COMMAND

The Host can use this command to generate a Reset Receiver software. The Host sends the following message:

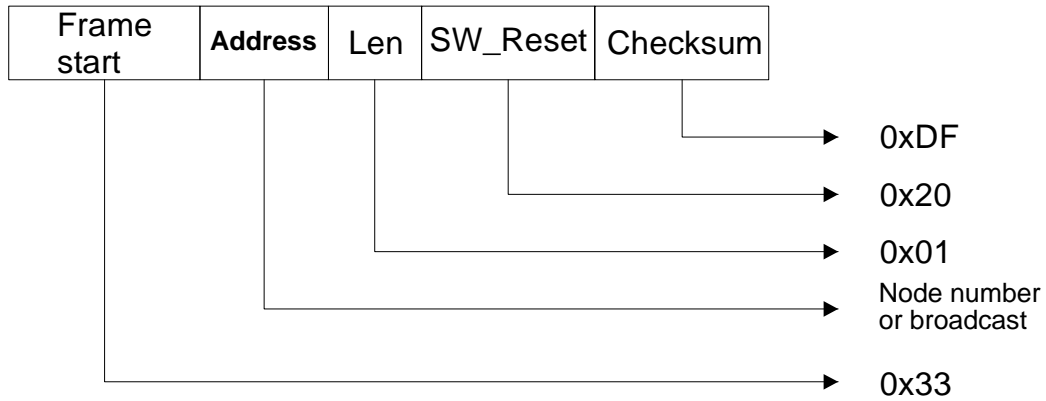

CORRECT OPERATION

The Receiver does not send a reply message (even if the node number is not the Broadcast number) and executes a system reset. A character is shown on the Display. Please see the METRON use and maintenance handbook (code 8540639, "**Signals**" section).

ERROR HANDLING

1. If the message received contains a corrupt checksum or the length field contains a value exceeding the maximum value allowed and the address is not Broadcast, the Receiver replies as follows:

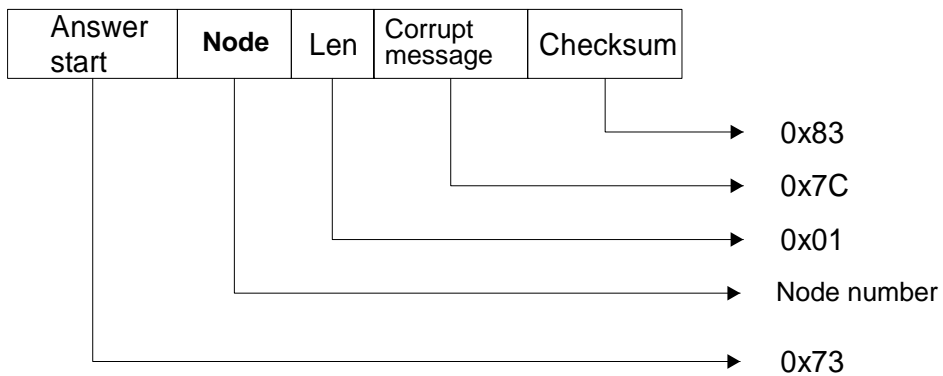

and the reset software command is not executed.

2. If the message received is correct, but the length is not, the Receiver replies as follows:

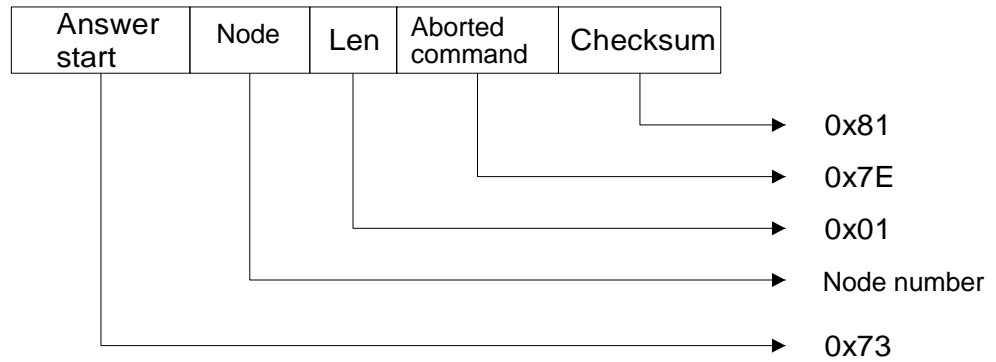

and the reset software command is not executed.

ENABLE OSSD COMMAND

The Host can use this command to enable the previously disabled OSSD functions. The Host must send the following message:

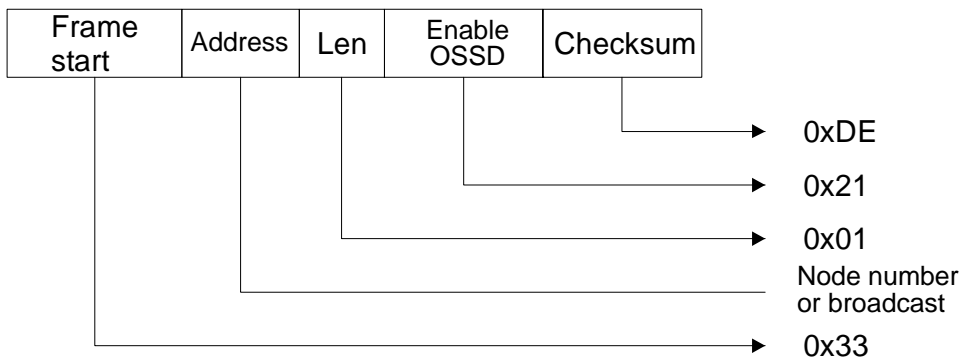

CORRECT OPERATION

The Receiver replies with the following message:

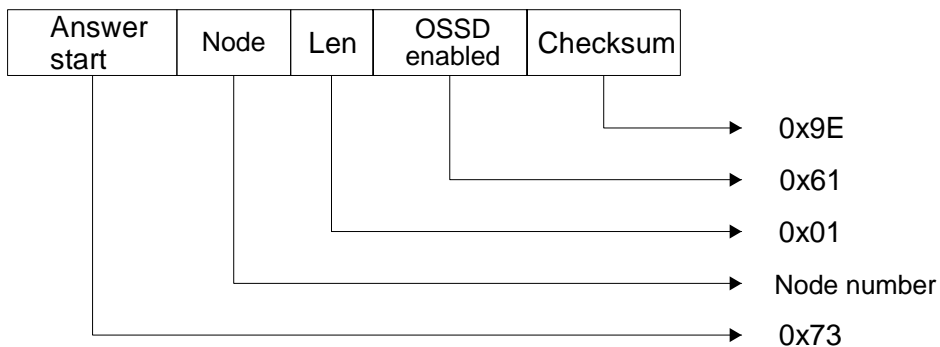

and the enable OSSD command is executed. If the address is Broadcast, the command is executed without the reply.

ERROR HANDLING

1. If the message received contains a corrupt checksum or the length field contains a value exceeding the maximum value allowed, the Receiver replies as follows:

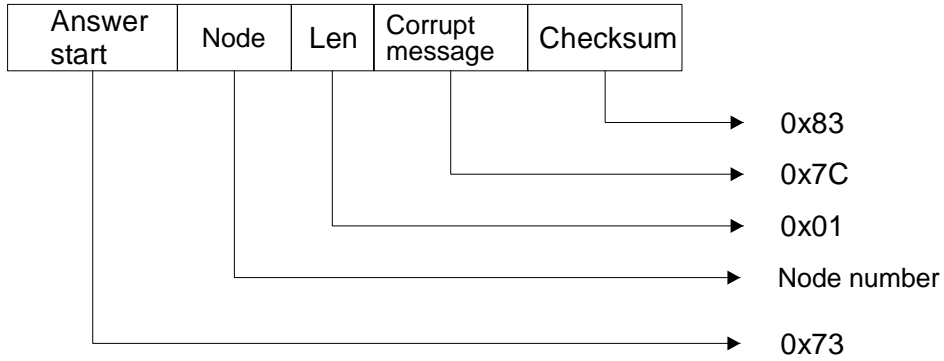

and the enable OSSD command is not executed.

2. If the message received is correct, but the “input_type” parameter is not configured as *No_function* or the length is not correct, the Receiver replies as follows:

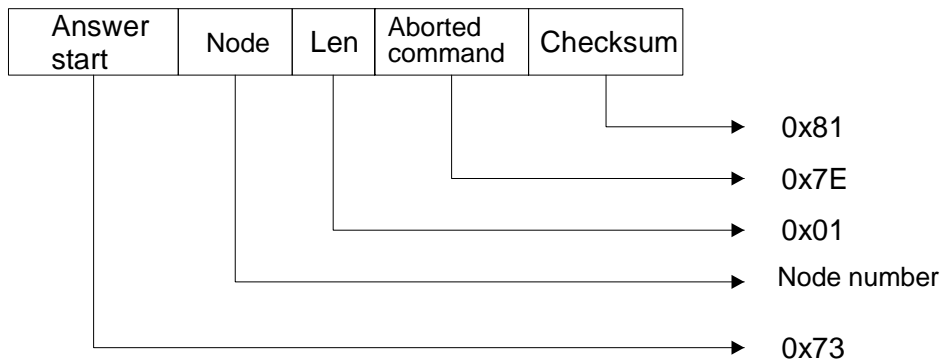

and the enable OSSD command is not executed.

DISABLE OSSD COMMAND

The Host can use this command to disable all the previously enabled OSSD functions. The Host must send the message:

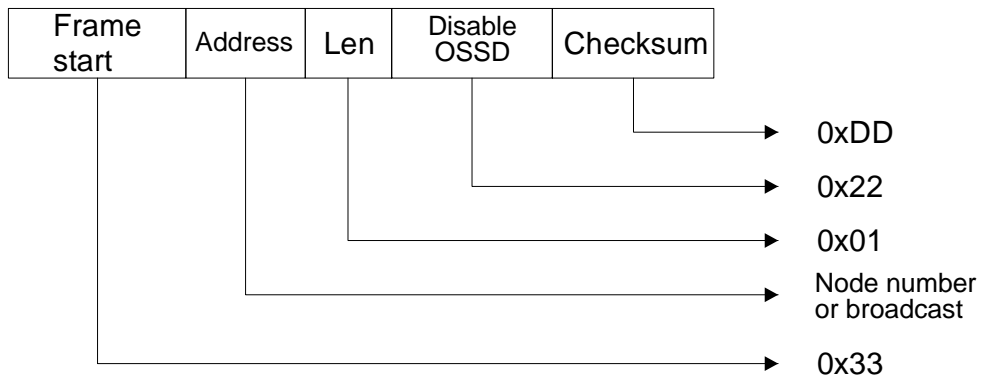

CORRECT OPERATION

The Receiver replies with the following message:

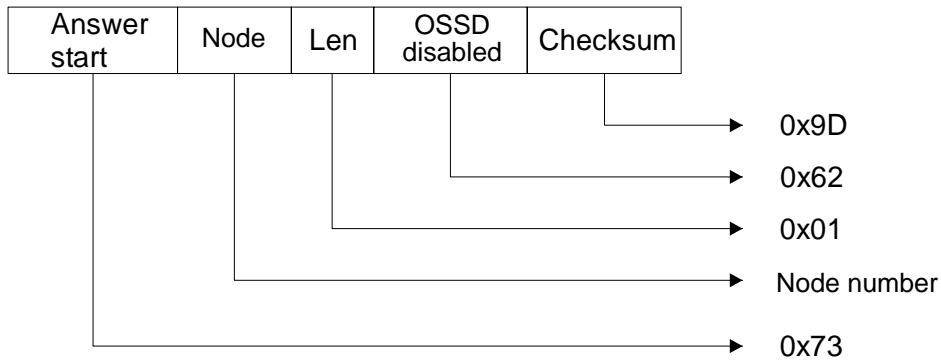

and executes the disable OSSD command. If the address is Broadcast, the command is executed without the reply.

ERROR HANDLING

1. If the message received contains a corrupt checksum or the length field contains a value exceeding the maximum value allowed, the Receiver replies as follows:

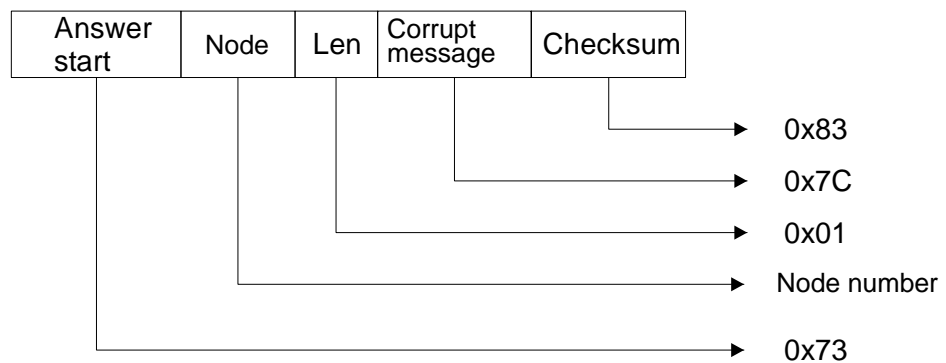

and the disable OSSD command is not executed.

2. If the message received is correct, but the “input_type” parameter is not configured as *No_function* or the length is not correct, the Receiver replies as follows:

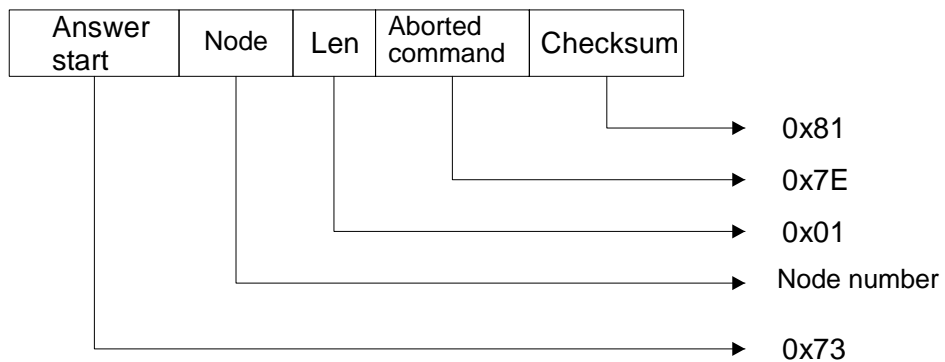

and the disable OSSD command is not executed.

3. If the message received is correct, but the OSSD status was not enabled, the Receiver replies as follows:

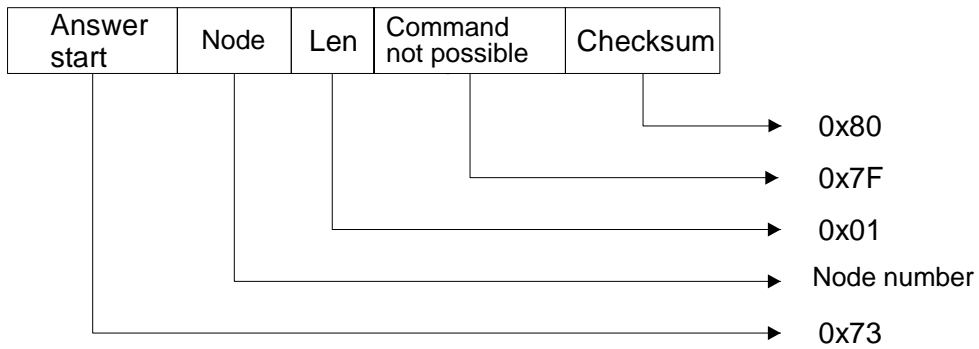

and the disable OSSD command is not executed.

OSSD STAND-BY COMMAND

The Host can use this command to put all the previously enabled OSSD functions in Stand-by. The Host sends the message:

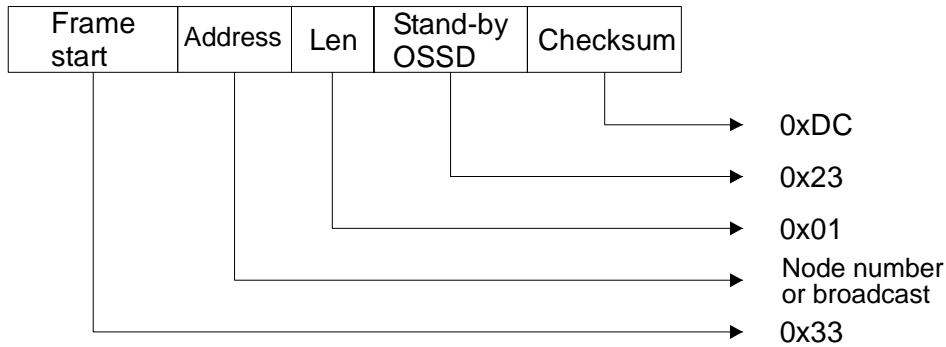

CORRECT OPERATION

The Receiver replies with the following message:

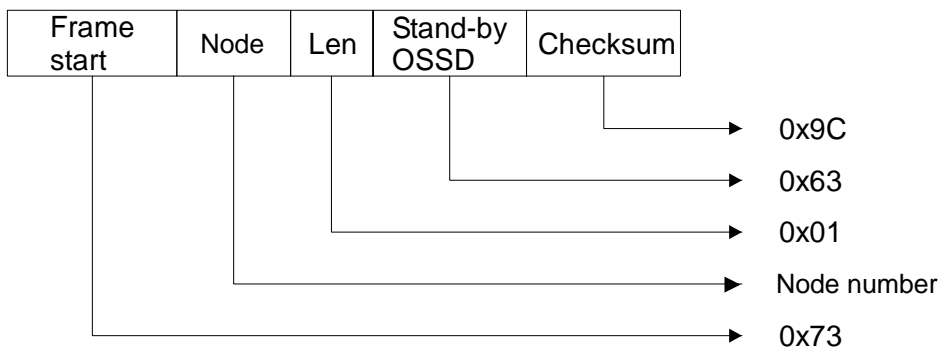

and executes the all OSSDs in stand-by command. If the address is Broadcast, the command is executed without sending a reply.

ERROR HANDLING

1. If the message received contains a corrupt checksum or the length field contains a value exceeding the maximum value allowed, the Receiver replies as follows:

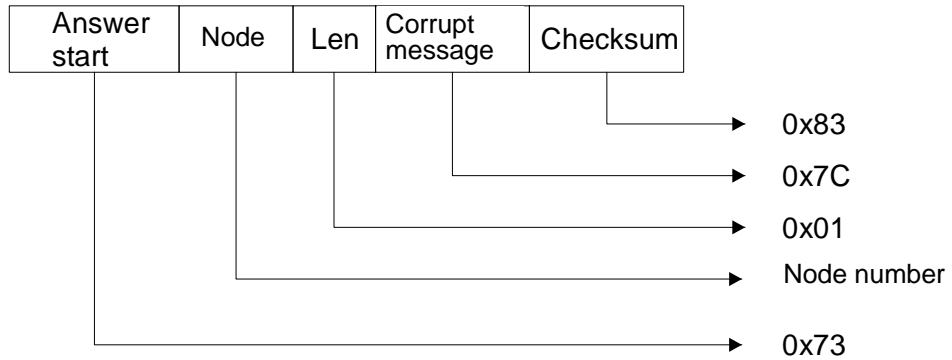

and the OSSD stand-by command is not executed.

2. If the message received is correct, but the “input_type” parameter is not configured as *No_function* or the length is not correct, the Receiver replies as follows:

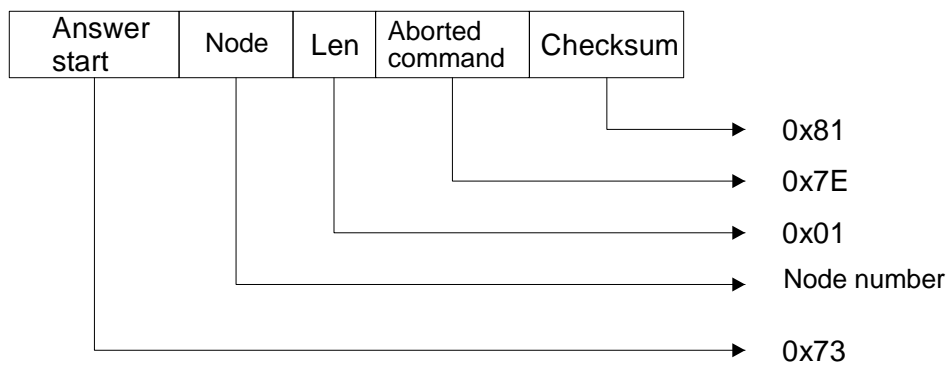

and the OSSD stand-by command is not executed.

3. If the message received is correct, but the OSSD status was not enabled, the Receiver replies as follows:

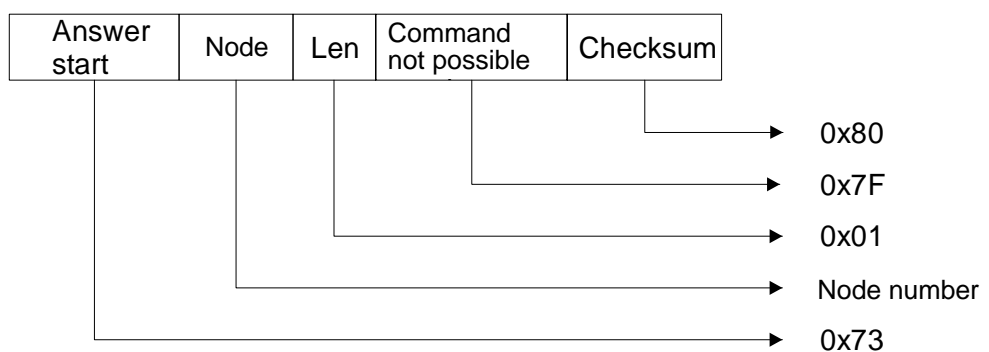

and the OSSD stand-by command is not executed.

START OSSD MEASUREMENT COMMAND

The Host can use this command to start a Start/Stop-type measurement phase on all the enabled OSSD functions. The Host sends the message:

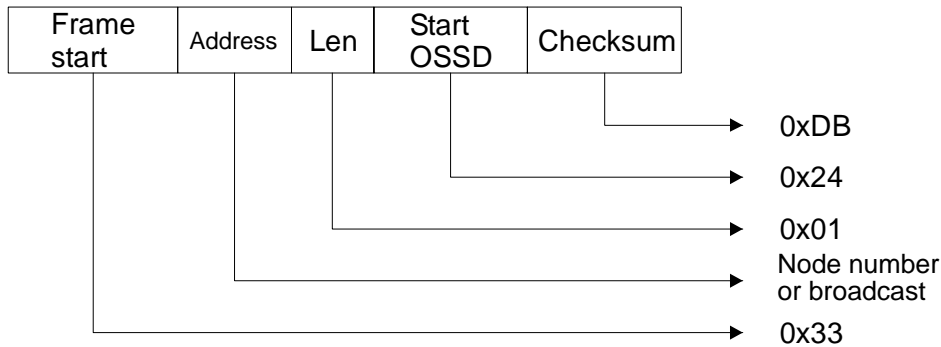

CORRECT OPERATION

The Receiver replies with the following message:

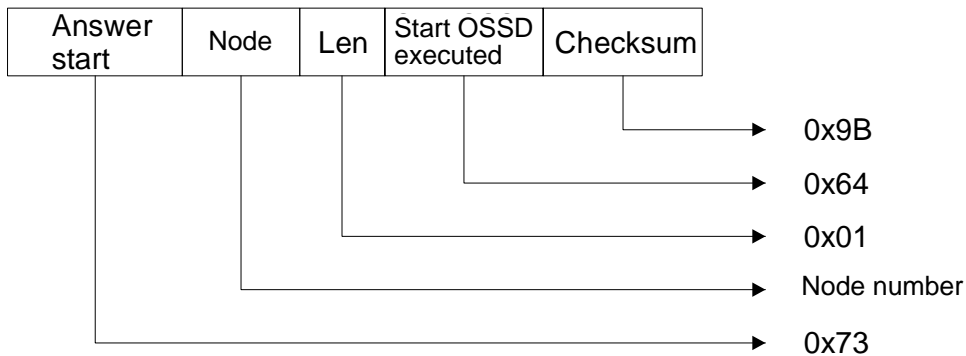

and starts the Start/Stop measurement procedure on all the enabled OSSD functions. If the address is Broadcast, the command is executed without sending a reply.

ERROR HANDLING

1. If the message received contains a corrupt checksum or the length field contains a value exceeding the maximum value allowed, the Receiver replies as follows:

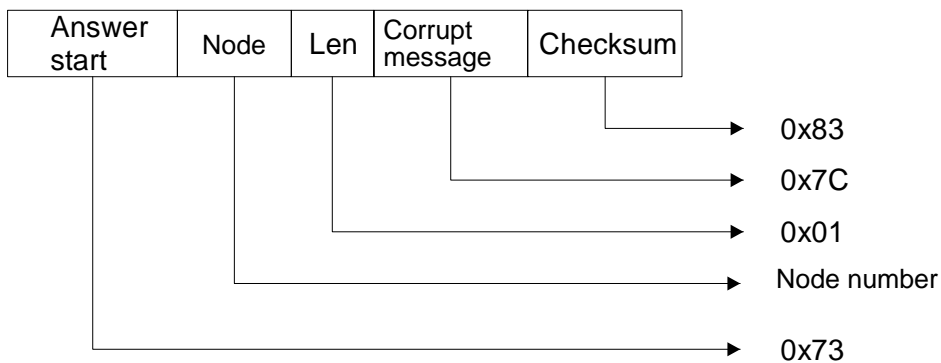

and the Start OSSD command is not executed.

- If the message received is correct, but the "input_type" parameter is not configured as *No_function* or the length is not correct, the Receiver replies as follows:

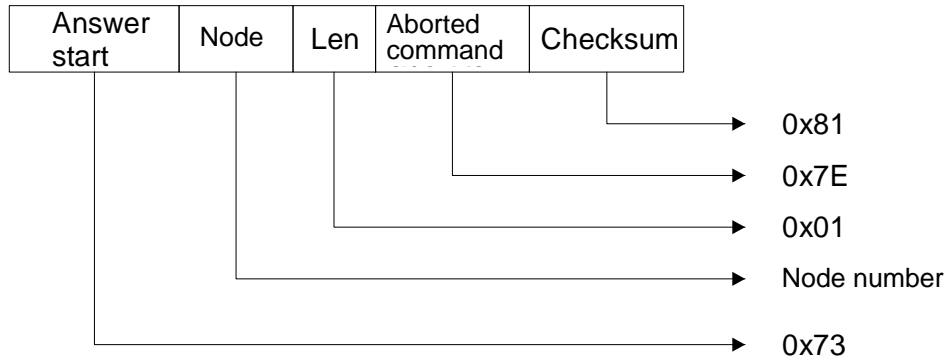

and the Start OSSD command is not executed.

- If the message received is correct, but the OSSD status was not enabled, the Receiver replies as follows:

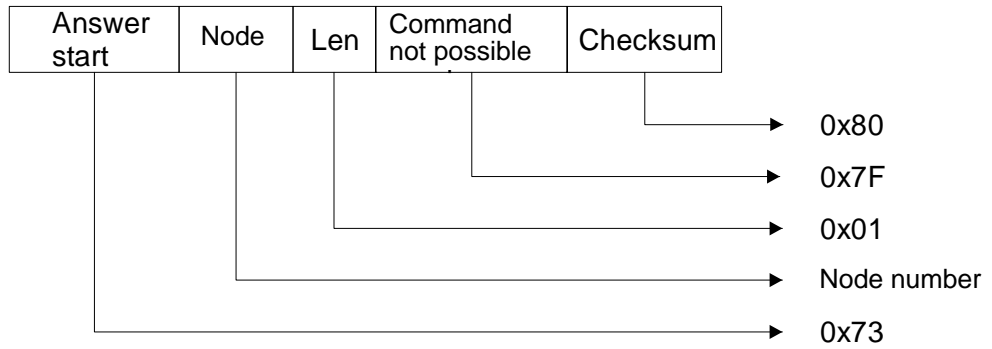

and the Start OSSD command is not executed.

STOP OSSD MEASUREMENT COMMAND

The Host can use this command to end a Start/Stop-type measurement phase on all the enabled OSSD functions. The Host sends the message:

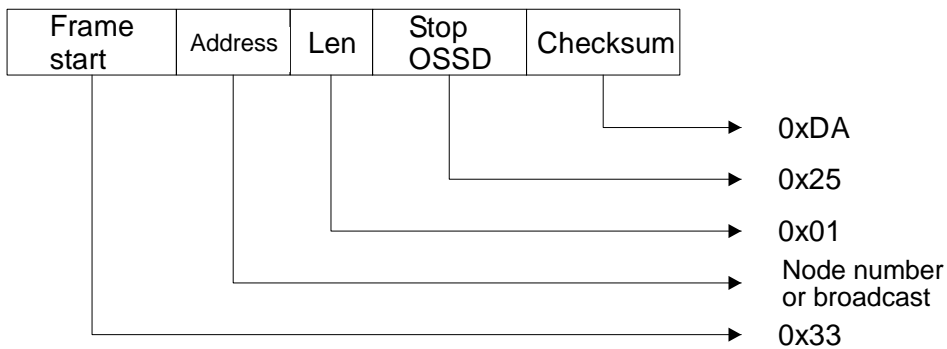

CORRECT OPERATION

The Receiver replies with the following message:

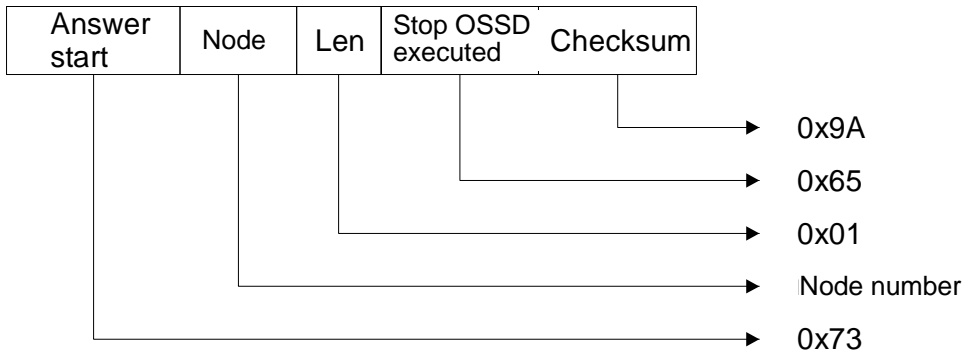

and ends the Start/stop measurement procedure on all the enabled OSSD functions, generating the OSSDs. If the address is Broadcast, the command is executed without sending a reply.

ERROR HANDLING

1. If the message received contains a corrupt checksum or the length field contains a value exceeding the maximum value allowed, the Receiver replies as follows:

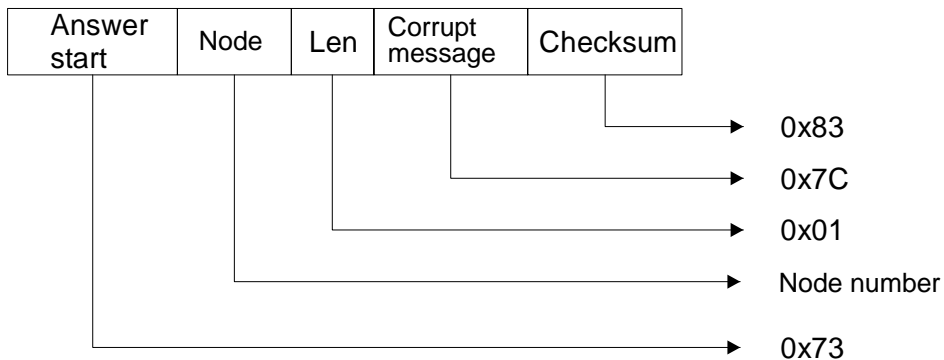

and the Stop OSSD command is not executed.

2. If the message received is correct, but the “input_type” parameter is not configured as *No_function* or the length is not correct, the Receiver replies as follows:

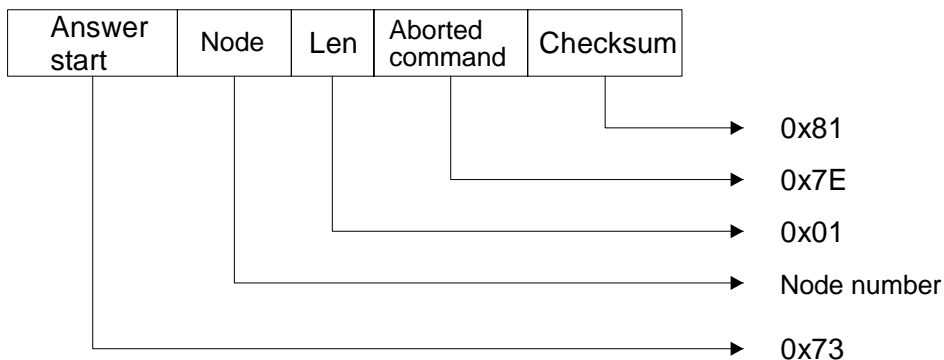

and the Stop OSSD command is not executed.

3. If the message received is correct, but the previous message was not to Start, the Receiver replies as follows:

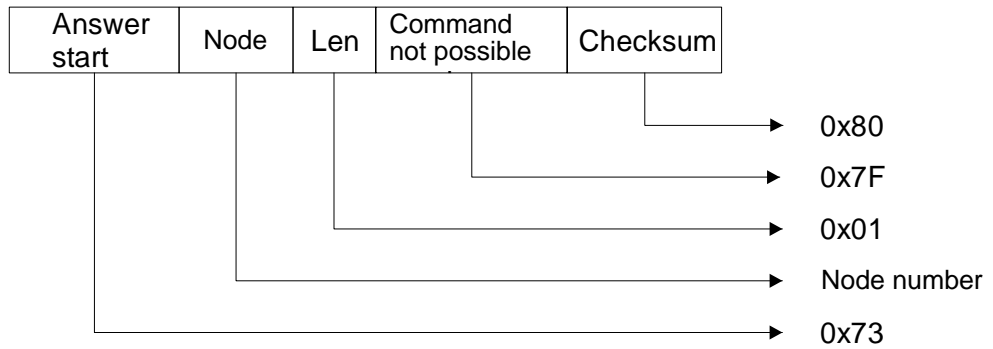

and the Stop OSSD command is not executed.

START MEASUREMENT COMMAND

The Host can use this command to start a Start/Stop-type measurement phase specifying a measurement field at will. The Host sends the message:

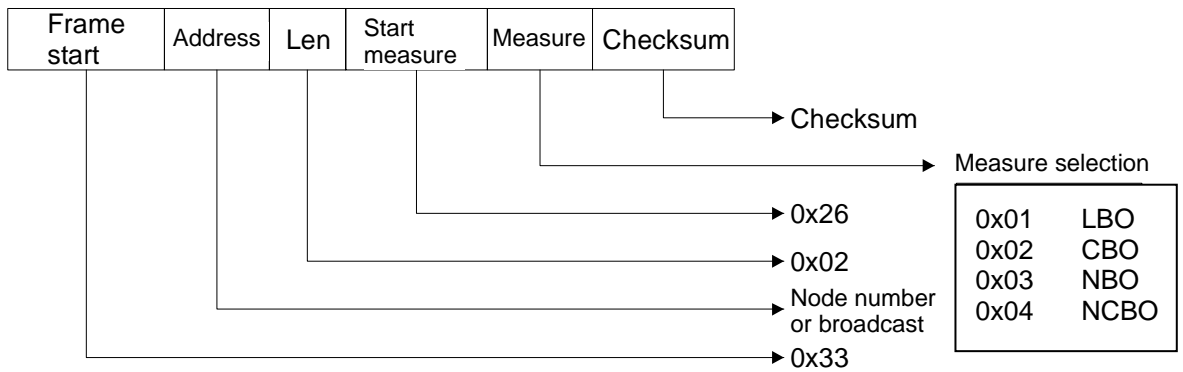

CORRECT OPERATION

The Receiver replies with the following message:

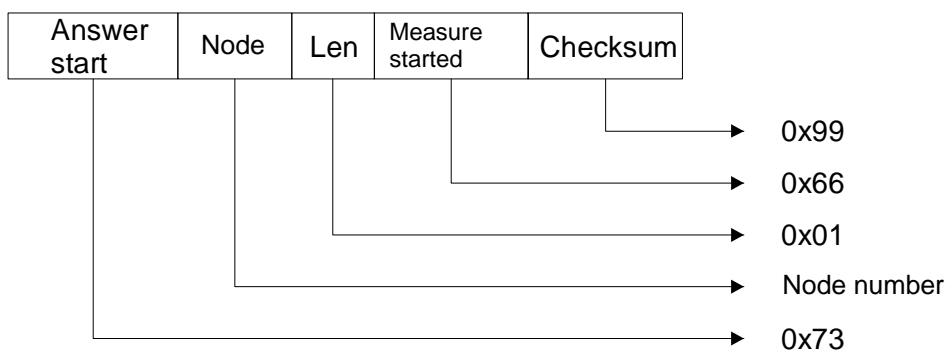

and starts the Start/Stop measurement procedure on the desired field. If the address is Broadcast, the command is executed without sending a reply.

ERROR HANDLING

1. If the message received contains a corrupt checksum or the length field contains a value exceeding the maximum value allowed, the Receiver replies as follows:

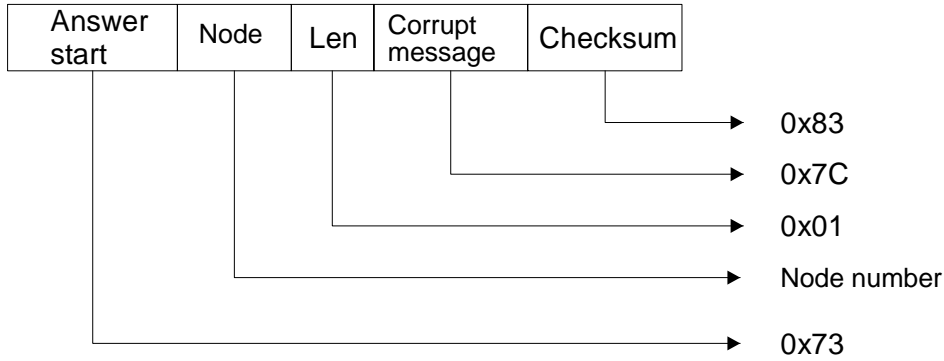

and the Start measurement command is not executed.

2. If the message received contains a length other than 2 (the measurement is not specified or there is more than one) or the field measurement value is not among those allowed, the Receiver replies as follows:

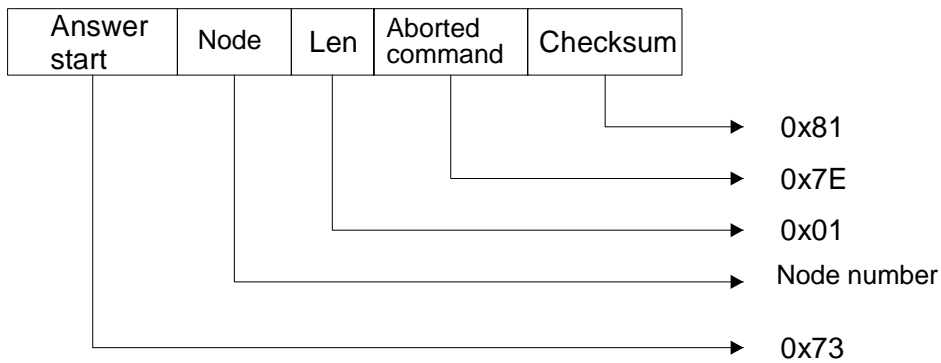

and the Start measurement command is not executed.

3. If the message received is correct, but the synchronism is missing, the Receiver replies as follows:

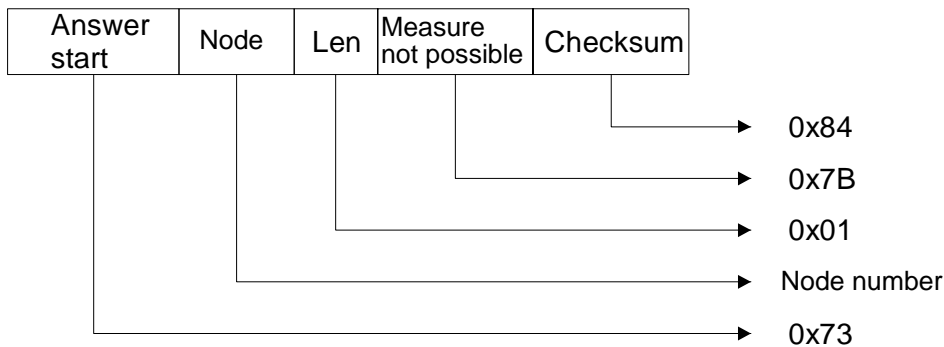

and the Start measurement command is not executed.

STOP MEASUREMENT COMMAND

The Host can use this command to end a previously activated Start/Stop-type measurement phase. The Host sends the message:

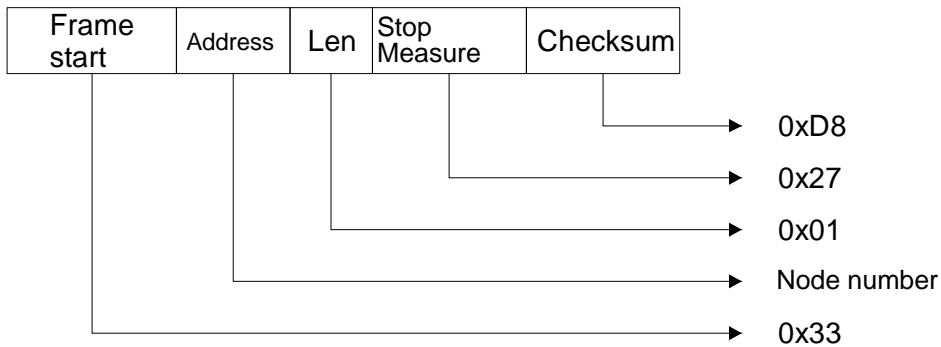

CORRECT OPERATION

The Receiver replies with the following message:

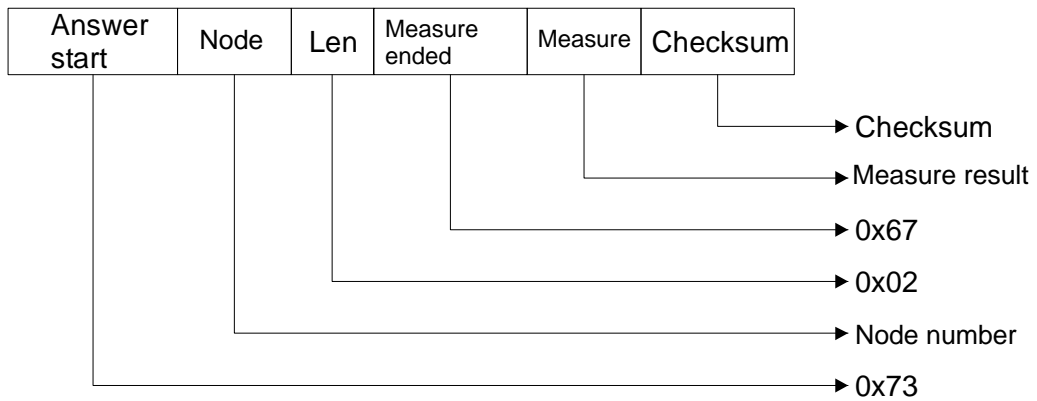

and ends the Start/Stop measurement procedure on the requested field. If the address is Broadcast, the command is ignored and the measurement phase continues.

ERROR HANDLING

1. If the message received contains a corrupt checksum or the length field contains a value exceeding the maximum value allowed, the Receiver replies as follows:

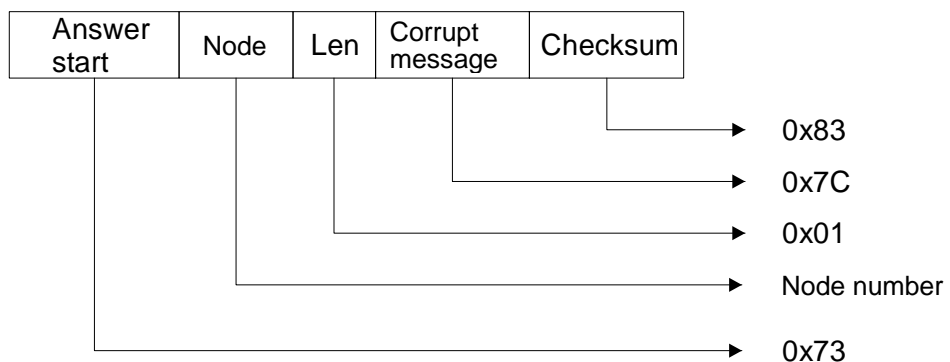

and the Stop measurement command is not executed.

2. If the message received contains a length other than 1, the Receiver replies as follows:

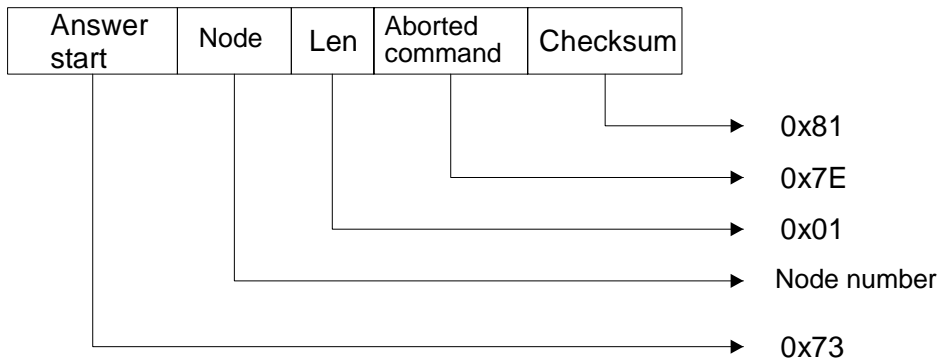

and the Stop measurement command is not executed.

3. If the message received is correct, but the synchronism is missing, the Receiver replies as follows:

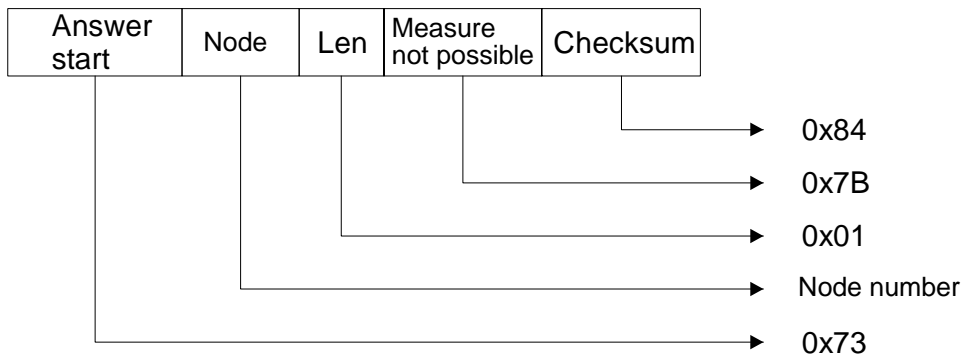

and the Stop measurement command is not executed.

4. If the message received is correct, but the previous message was not to Start measurement, the Receiver replies as follows:

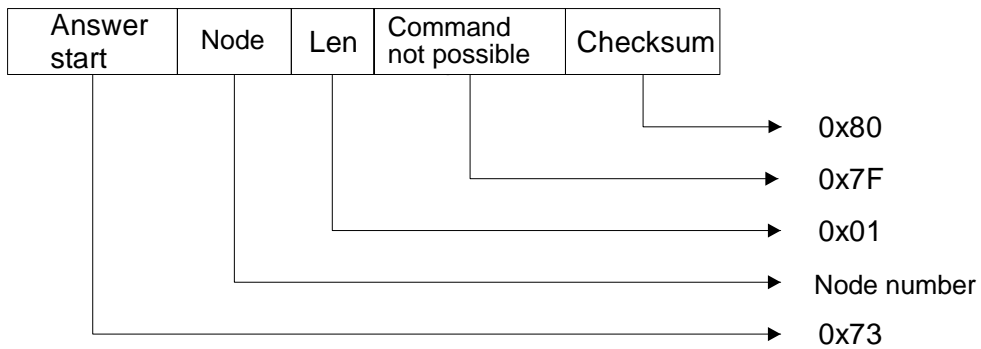

and the Stop measurement command is not executed.

REQUEST ACTIVE BEAM STATUS COMMAND

The Host can use this command to request the status of a single beam or of all the active beams of the light curtain. The Host sends one of the following messages:

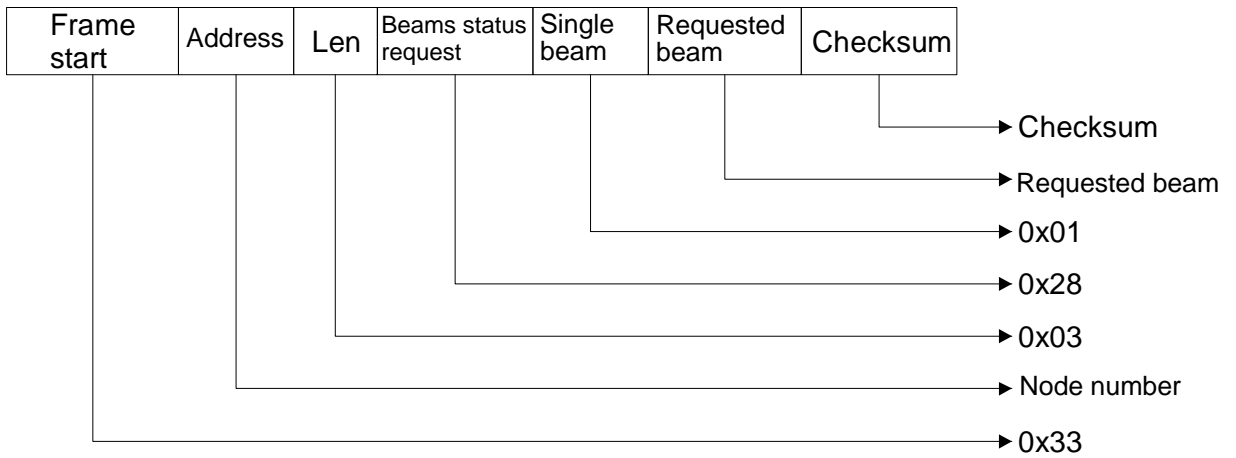

or

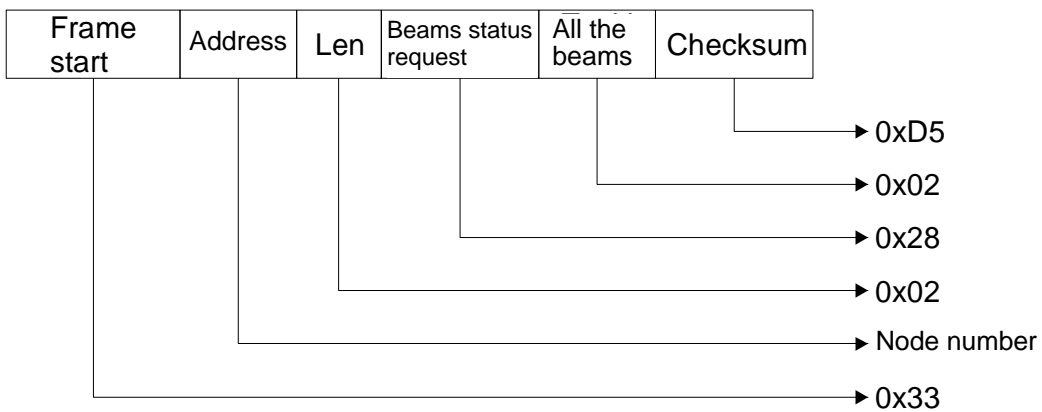

CORRECT OPERATION

The Receiver replies with the following message:

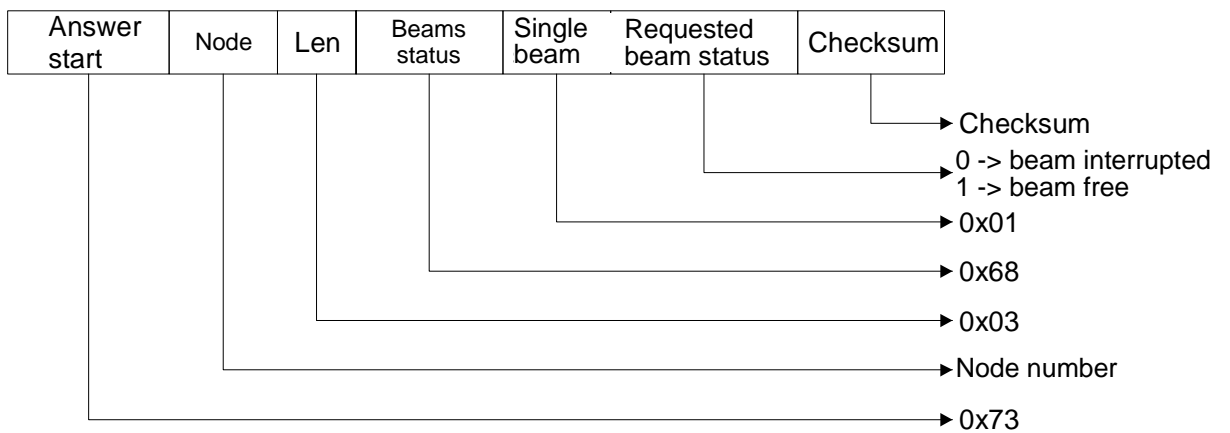

and sends the status of the requested beam. If the address is Broadcast, the command is ignored.

Or:

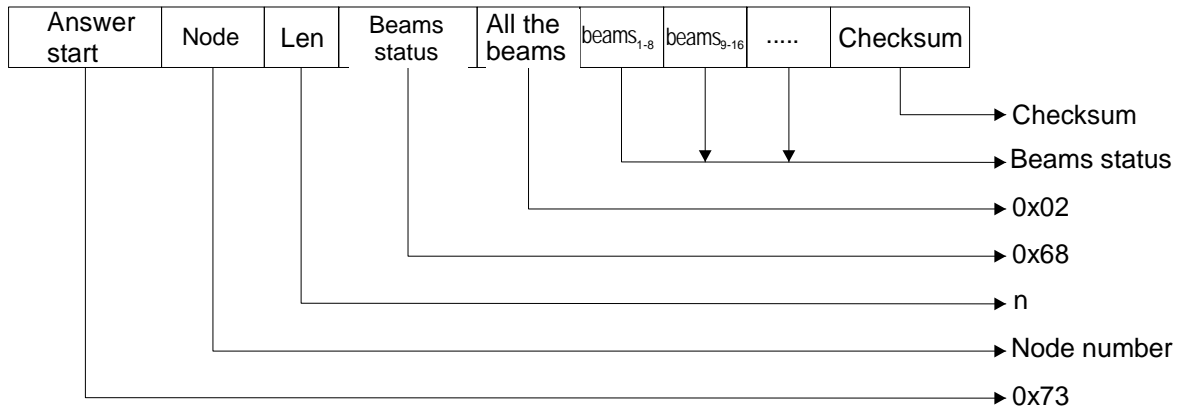

and sends the status of all the beams. If the address is Broadcast, the command is ignored. The status of each beam takes up one bit of each byte that is transmitted: e.g., a 24-beam light curtain will send 3 bytes in which each bit represents the status of each beam starting from the first; a 30-beam light curtain will send 4 bytes, with the last two bits of the last byte as X.

ERROR HANDLING

1. If the message received contains a corrupt checksum or the length field contains a value exceeding the maximum value allowed, the Receiver replies as follows:

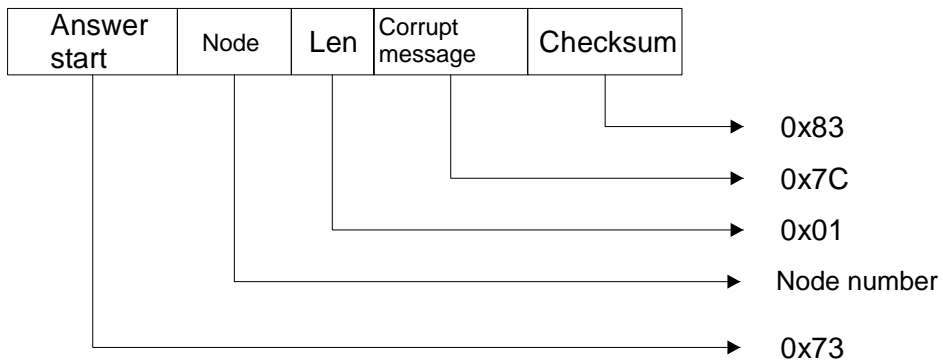

and the requested beam status is not sent.

2. If the message received contains an incorrect length or the single beam requested does not exist or the request is other than for a single beam or all beams, the Receiver replies as follows:

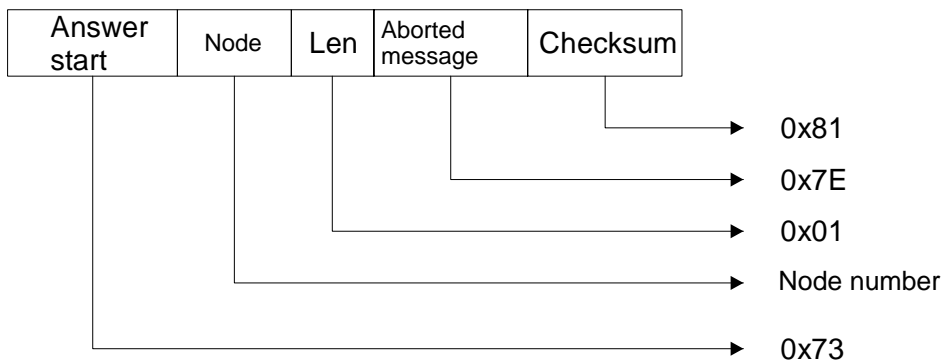

and the requested beam status is not sent.

REQUEST INSTANTANEOUS MEASUREMENTS COMMAND

The Host can use this command to request the current value of one or more available measurements. The Host sends the message:

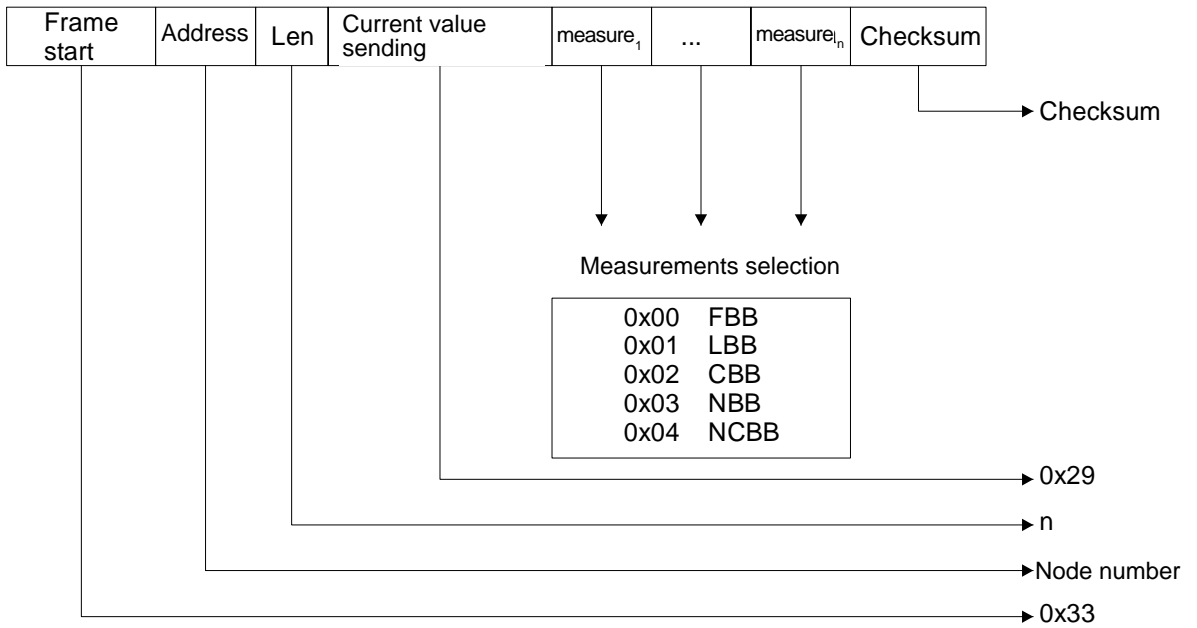

CORRECT OPERATION

The Receiver replies with the following message:

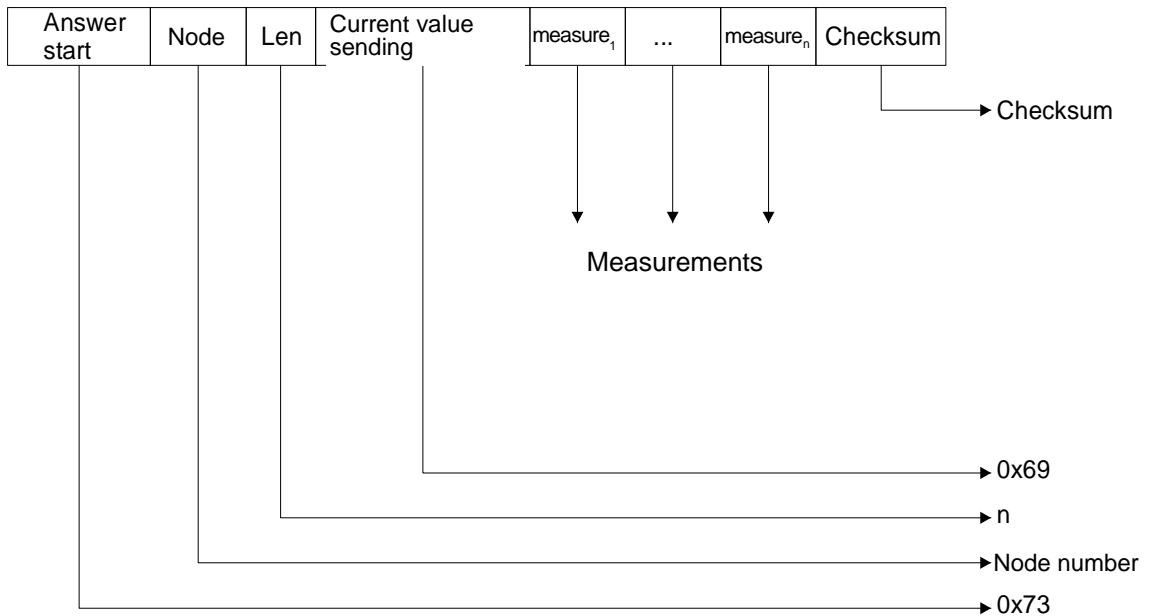

and sends the requested measurements. If the address is Broadcast, the command is ignored.

ERROR HANDLING

1. If the message received contains a corrupt checksum or the length field contains a value exceeding the maximum value allowed, the Receiver replies as follows:

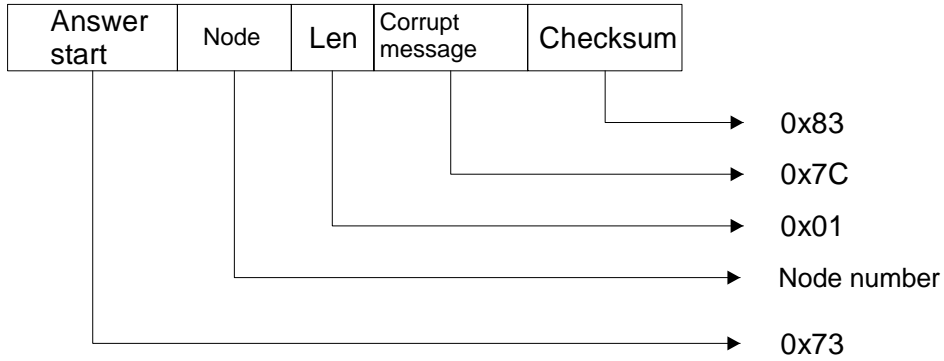

and the requested measurement is not sent.

2. If the message received contains an incorrect length or the measurement field value is not among those allowed, the Receiver replies as follows:

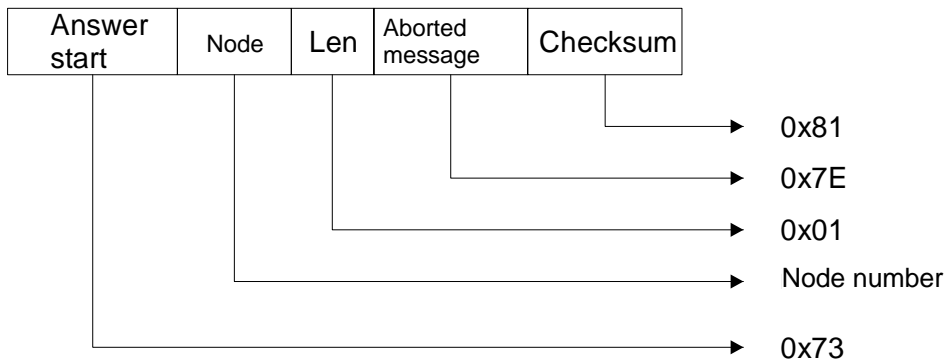

and the requested measurement is not sent.

3. If the message received is correct, but the synchronism is missing, the Receiver replies as follows:

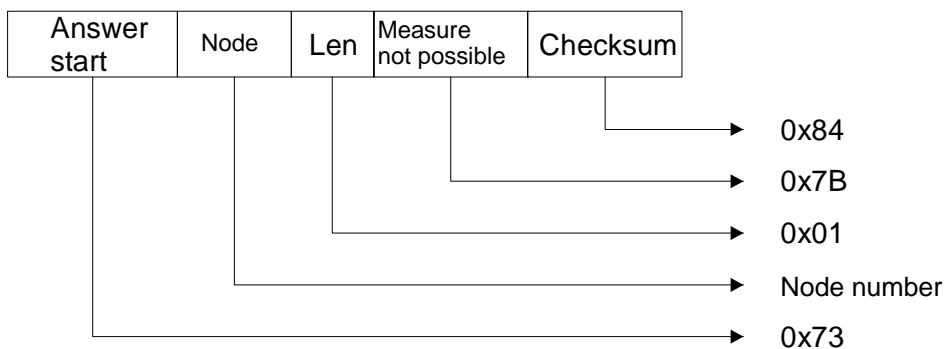

and the requested measurement is not sent.

REQUEST CONFIGURATION COMMAND

The Host can use this command to request Receiver configuration. The Host sends the message:

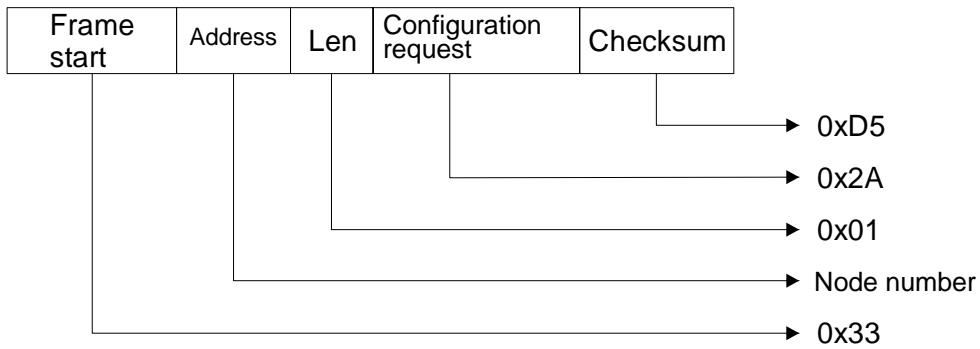

CORRECT OPERATION

The Receiver replies with the following message:

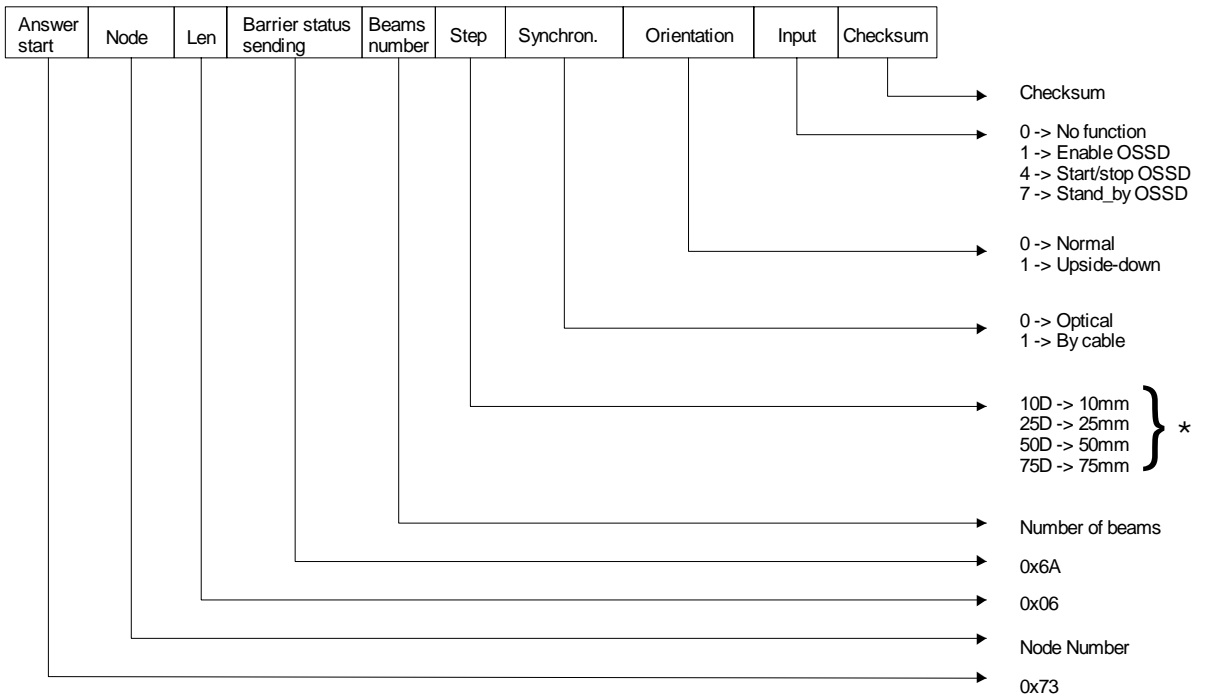

and sends the requested configuration. If the address is Broadcast, the command is ignored.

* *value in decimal mode*

ERROR HANDLING

1. If the message received contains a corrupt checksum or the length field contains a value exceeding the maximum value allowed, the Receiver replies as follows:

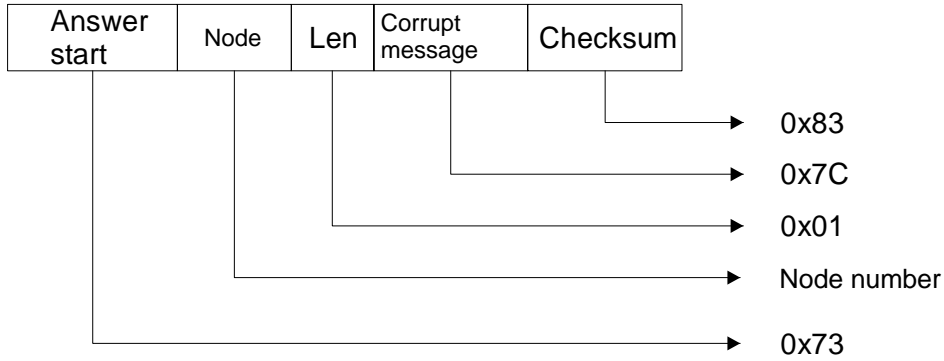

and the requested configuration is not sent.

2. If the message received contains an incorrect length, the Receiver replies as follows:

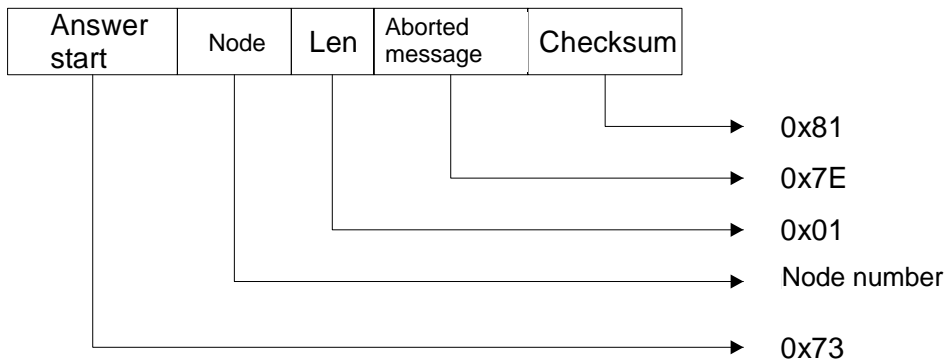

and the requested configuration is not sent.

REQUEST OSSD STATUS COMMAND

The Host can use this command to request the current status of the two OSSDs The Host sends the message:

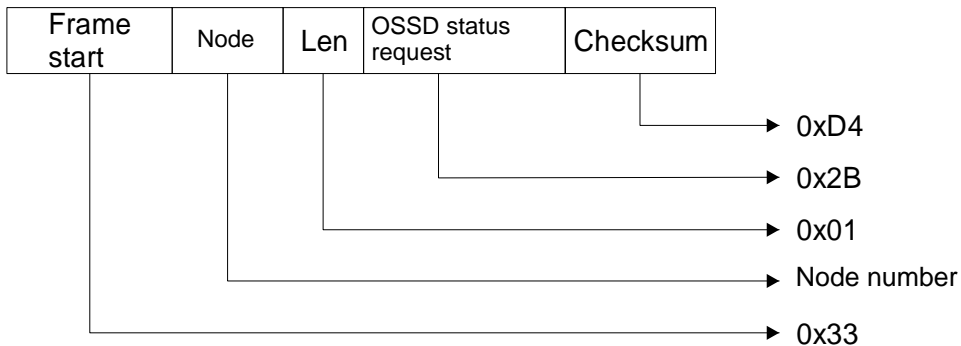

CORRECT OPERATION

The Receiver replies with the following message:

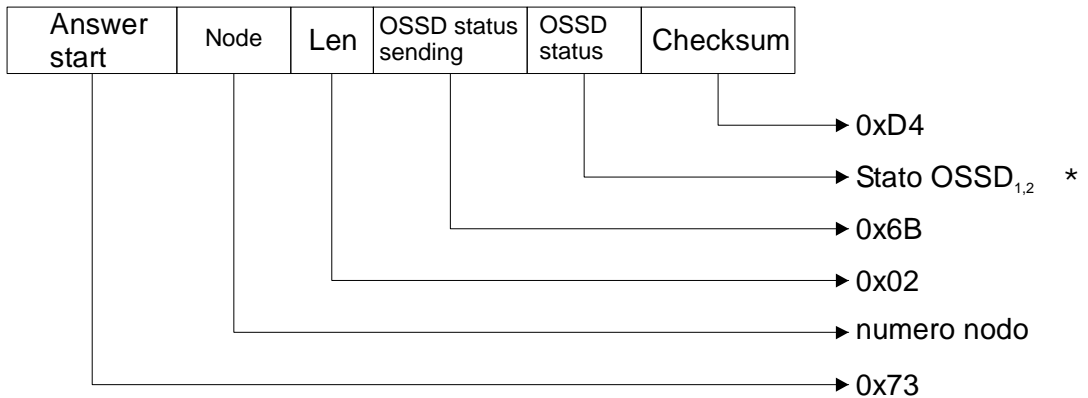

and sends the requested OSSD status. If the address is Broadcast, the command is ignored.

* **where 0 means OSSD in OFF status**
where 1 means OSSD in ON status

ERROR HANDLING

1. If the message received contains a corrupt checksum or the length field contains a value exceeding the maximum value allowed, the Receiver replies as follows:

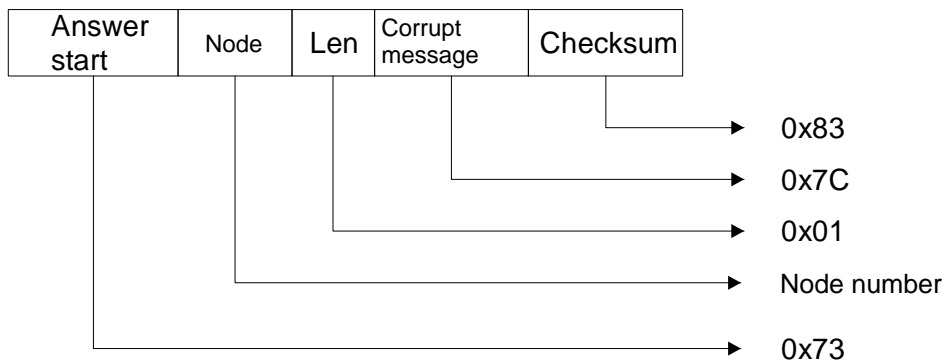

and the requested OSSD status is not sent.

2. If the message received contains an incorrect length, the Receiver replies as follows:

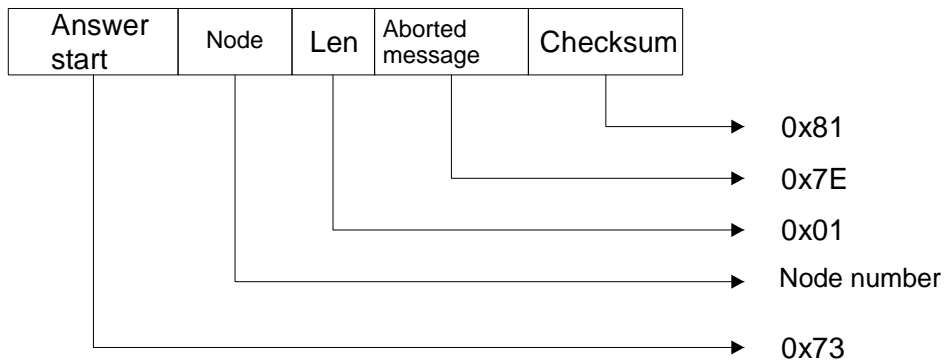

and the requested OSSD status is not sent.

REQUEST LIGHT CURTAIN STATUS COMMAND

The Host can use this command to request the current status of the Receiver. The Host sends the message:

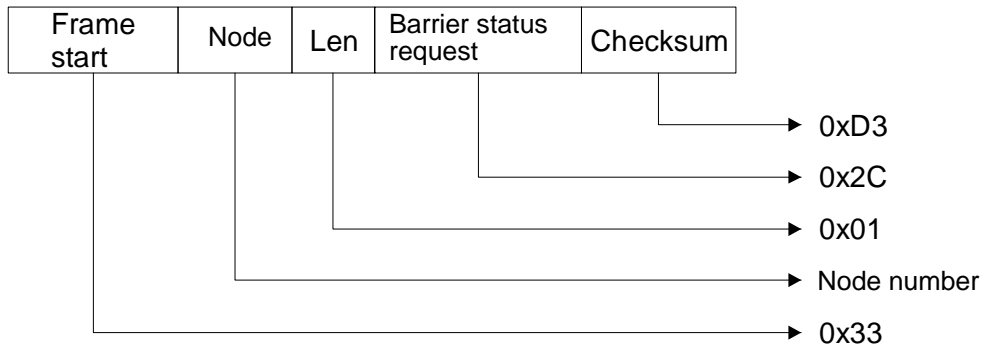
CORRECT OPERATION

The Receiver replies with the following message:

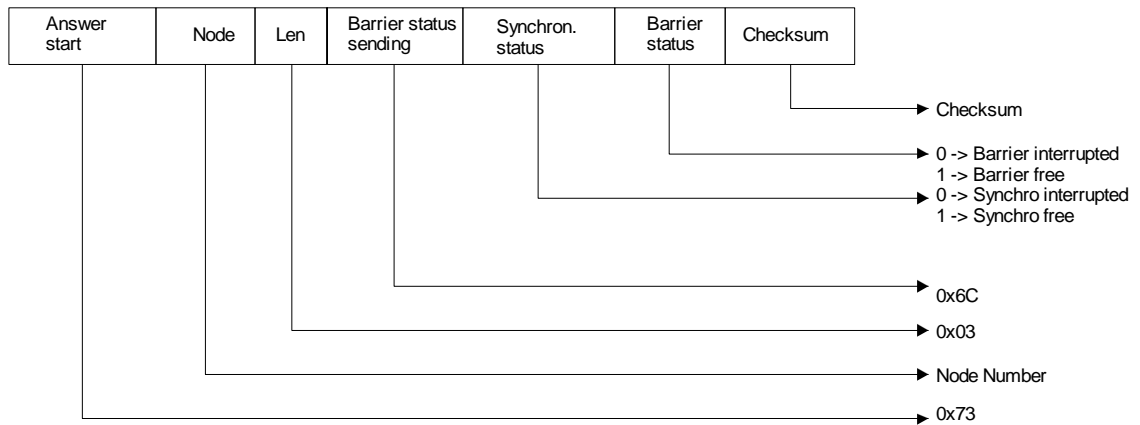

and sends the requested light curtain status. If the address is Broadcast, the command is ignored.

ERROR HANDLING

- If the message received contains a corrupt checksum or the length field contains a value exceeding the maximum value allowed, the Receiver replies as follows:

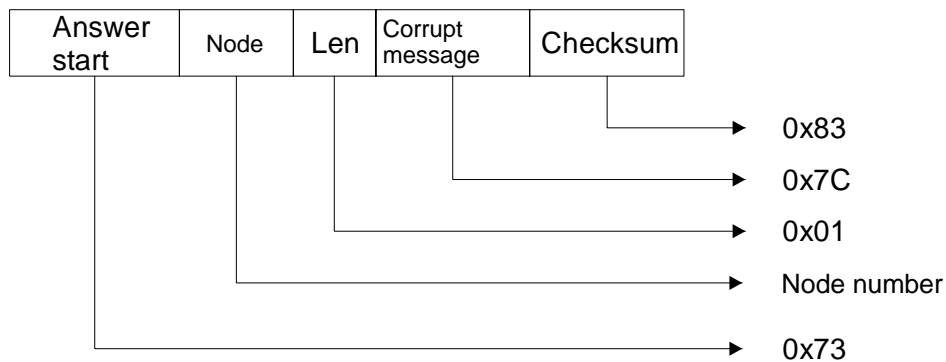

and the requested light curtain status is not sent.

2. If the message received contains an incorrect length, the Receiver replies as follows:

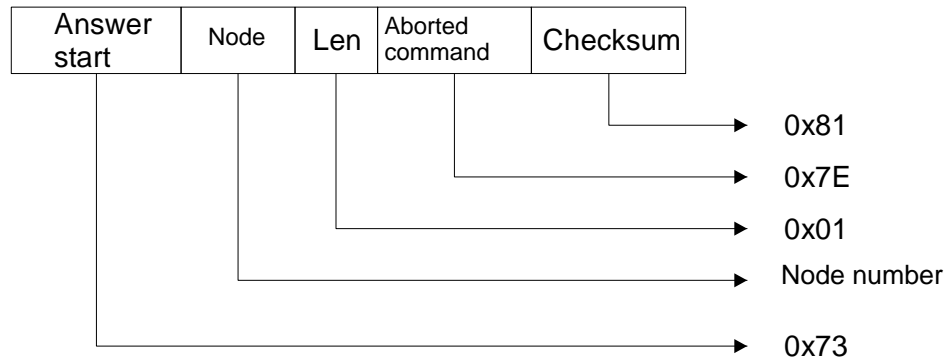

and the requested light curtain status is not sent.

METRON



REER S.p.A.

32 via Carcano

10153 Turin Italy

Tel. +39/0112482215 (lead No.)

Fax +39/011859867

Internet: www.reer.it

e-mail: info@reer.it

