

CONTROL UNIT AUS X SERIES



INSTALLATION, USE AND MAINTENANCE

CONTROL UNIT AUS X SERIES INSTALLATION, USE AND MAINTENANCE

INDEX

INTRODUCTION	4
NEW SAFETY PARAMETERS FOR TYPE 2 BARRIERS AND MANDATORY LABELLING	5
AUS X CONTROL UNIT.....	6
OPERATING MODES DESCRIPTION	6
AUTOMATIC.....	6
MANUAL.....	7
CONNECTION OF EXTERNAL CONTACTORS K1 and K2.....	7
CONNECTON EXAMPLES	8
CONNECTION OF AUS X WITH 2 COUPLES OF ULISSE/ILION PHOTOCELLS (WITHOUT K1K2 EXTERNAL CONTACTORS).....	8
CONNECTION OF AUS X WITH 1 COUPLE OF ULISSE/ILION PHOTOCELLS (WITH K1K2 EXTERNAL CONTACTORS).....	9
SERIES CONNECTION OF AUS X WITH 2 COUPLES OF ULISSE/ILION PHOTOCELLS (WITH K1K2 EXTERNAL CONTACTORS).....	9
CONNECTION OF AUS X WITH 4 COUPLES OF ULISSE/ILION PHOTOCELLS (WITHOUT K1K2 EXTERNAL CONTACTORS).....	10
SIGNAL DESCRIPTION	11
The RESTART command.....	11
The SYSTEM_TEST command.....	12
K1K2 FEEDBACK input	12
SYSTEM STATUS output	12
INSTALLATION AND ELECTRICAL CONNECTIONS.....	12
Characteristics of the output circuit.	13
Use of K1 and K2 auxiliary contact elements.....	13
Warnings regarding the connection cables.	13
STATUS INDICATORS	14
DIMENSIONS	14
TECHNICAL DATA AUS X	15
Status indicators with 1 photocell.....	16
Status indicators with 2 photocells.....	17
FAULT DIAGNOSIS	17
MODULO AUS XM	18
OPERATING MODES DESCRIPTION	18
AUTOMATIC.....	18
MANUAL.....	19
CONNECTION OF EXTERNAL CONTACTORS K1 and K2.....	20
CONNECTON EXAMPLES	21
CONNECTION OF AUS XM WITH 2 COUPLES OF ULISSE/ILION PHOTOCELLS (MANUAL MODE, WITH K1K2 EXTERNAL CONTACTORS, TIMEOUT MUTING = 30s).....	21
CONNECTION OF AUS XM WITH 1 COUPLE OF ULISSE/ILION PHOTOCELLS (MANUAL MODE, WITH K1K2 EXTERNAL CONTACTORS, TIMEOUT MUTING = 30s).....	22
CONNECTION OF AUS XM WITH 2 COUPLES OF ULISSE/ILION PHOTOCELLS IN SERIES (MANUAL MODE, WITH K1K2 EXTERNAL CONTACTORS, TIMEOUT MUTING = 30s).....	23
CONNECTION OF AUS XM WITH 4 COUPLES OF ULISSE/ILION PHOTOCELLS IN SERIES (AUTOMATIC MODE, TIMEOUT MUTING = ∞).....	24

MUTING FUNCTION	24
Muting sequence	25
MUTING OVERRIDE FUNCTION	26
Override with maintained action control	27
Override with pulse control	27
SIGNALS DESCRIPTION	28
The RESTART command	29
The SYSTEM_TEST command	29
K1K2 FEEDBACK input	30
SYSTEM STATUS output	30
INSTALLATION AND ELECTRICAL CONNECTIONS	30
Characteristics of the output circuit.	30
Use of K1 and K2 auxiliary contact elements.	31
Warnings regarding the connection cables	31
STATUS INDICATORS	32
DIMENSIONS	32
TECHNICAL DATA	33
Status indicators with 1 photocell connected	34
Status indicators with 2 photocells connected	34
Status indicators (MUTING module)	34
Fault diagnosis	35
Fault diagnosis (modulo MUTING)	35
GUARANTEE	36

 This symbol indicates an important personal safety warning. Failure to comply with the warning may result in very high risk for exposed personnel.

INTRODUCTION

The ReeR AUS X control unit is a safety device complying with IEC 61496-1, IEC 61496-2 specifications. When connected to a Ilion or a ULISSE/ILION UPC safety photocell, it forms a type 2 ESPE (Electro-sensitive Protective Equipment).

The AUS X main features are the following:

- Possible connections: from 1 to 4 photocells
- Restart manual or automatic selectable
- 2 N.O. outputs with guided contact safety relays
- 1 system monitor PNP output
- 1 external contactors feedback input
- Connected safety photocells periodic autotest (every 5s) .

The AUS XM main features are the following:

- Possible connections: from 1 to 4 photocells
- Manual or automatic selectable Restart
- 2 N.O. outputs with guided contact safety relays
- 1 system monitor PNP output
- 1 external contactors feedback input
- Muting function with two sensors logic
- 1 Muting function enable input
- 1 muting lamp output
- Muting Override function integrated
- Selectable muting timeout
- Connected safety photocells periodic autotest (every 5s).

The control unit also guarantees that:

- the output lines are open if the photocell is intercepted;
- the output lines are enabled only with correct response times;
- in manual mode, maintenance of the RESTART contact closed is not interpreted as AUTO mode.

 For safe use of the device, it is essential to read and understand the contents of this handbook.

 Failure to comply with the prescriptions indicated in this handbook may result in very high risks for the operating personnel of the machine protected.

 Carefully consider the risks analysis of the application and the legislation of the barrier application Country to establish if the application is compatible with the safety category 2.

NEW SAFETY PARAMETERS FOR TYPE 2 BARRIERS AND MANDATORY LABELLING

With the publication of Edition 3 of the harmonized EN 61496-1 standard it is no longer possible to use a Type 2 safety light barrier for safety functions assessed as SIL 2 / PL d.

If a safety level of SIL 2 / PL d (or higher) is required and it is nevertheless intended to use a safety light barrier, then it will be necessary to use a Type 4 safety light barrier.

This regulatory requirement derives from the fact that the reduction of risk that can be obtained via a photoelectric safety barrier is not only a function of the safety level of its electronic parts, but is also determined by its systematic capabilities (for example: environmental influences, EMC, optical performance and detection principle).



The systematic capability of a Type 2 photoelectric barrier may in fact not be sufficient to ensure adequate risk reduction for SIL 2 / PL d applications.

The standard also establishes that the labelling of Type 2 safety barriers must indicate such limitation to SIL 1 / PL c.

The PFHd values declared for the electronic control part of the device, on the other hand, are not limited and therefore it is possible to use the PFHd value provided by the manufacturer of the device in the global assessment of the safety function, even if it exceeds the SIL 1 / PLc range.

AUS X CONTROL UNIT

OPERATING MODES DESCRIPTION

OPERATING MODES SELECTION		
TERMINAL 5	TERMINAL 4	OPERATION
0 Vdc	+24 Vdc	<i>Automatic</i>
+24 Vdc	+24 Vdc through a N.O. contact	<i>Manual</i>
0 Vdc	0 Vdc	<i>Non-permissible conditions</i>
+24 Vdc	+24 Vdc	

Table 1

AUTOMATIC

In this operating mode, the outputs of the control unit follow the status of the photocell:

- with the protected area free (outputs of the photocells active), the relay outputs of the control unit are active.
- with the protected area occupied (outputs of the photocells de-activated), the relay outputs of the control unit are de-activated.

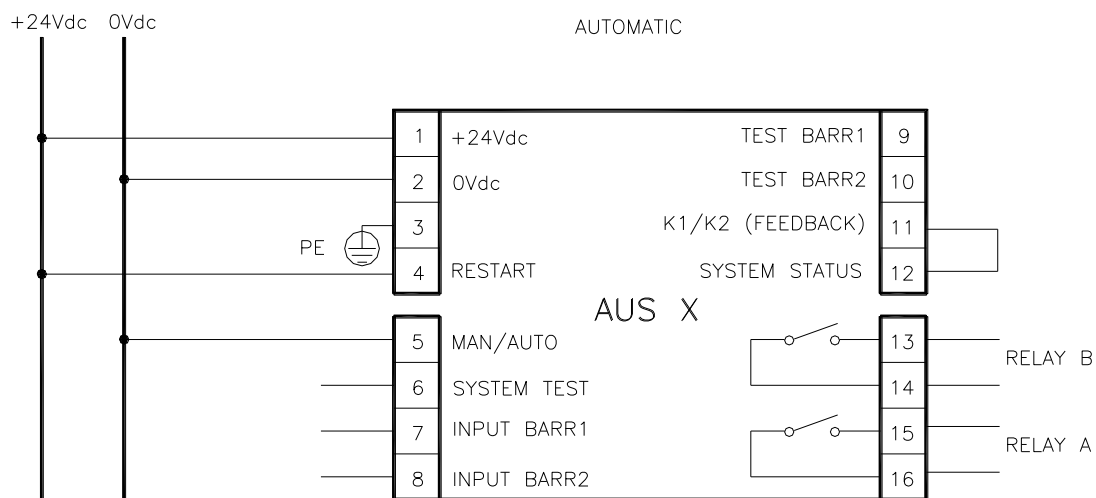

Figure 1

- ⚠ Use in manual mode (start/restart interlock activated) is mandatory in the case in which the safety device controls an access protecting a danger zone and once a person has passed through the opening, he/she may remain in the danger zone without being detected (use as trip device according to IEC 61496). Failure to comply with this rule may result in very serious risks for the persons exposed.
- ⚠ Check correct functioning of the entire safety system (control unit+photocell) following each re-installation. In particular, if the original operating mode was Manual, check that the unit has been reconfigured in this mode.

MANUAL

In this operating mode, the outputs of the control unit are activated only if the protected area is free and after sending the RESTART signal to the control unit using the push-button or by means of a specific command on the RESTART input (terminal 4).

Once the protected area has been occupied, the relay outputs are deactivated. The sequence described above must be repeated in order to re-activate them.

The RESTART command is active with a 0VDC ---> +24VDC transition. The minimum duration of the command is 100 ms.

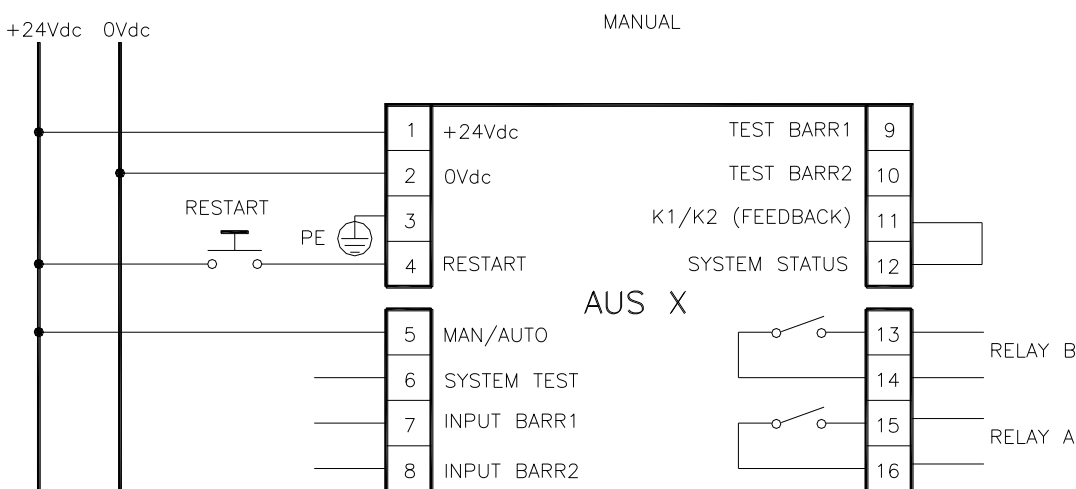

Figure 2

CONNECTION OF EXTERNAL CONTACTORS K1 and K2

Control of external contactors K1K2 can be activated in both operating modes. If this control must be used, the series of normally closed contacts of the external contactors must be connected to terminal 11 of the control unit (figures 3 and 4).

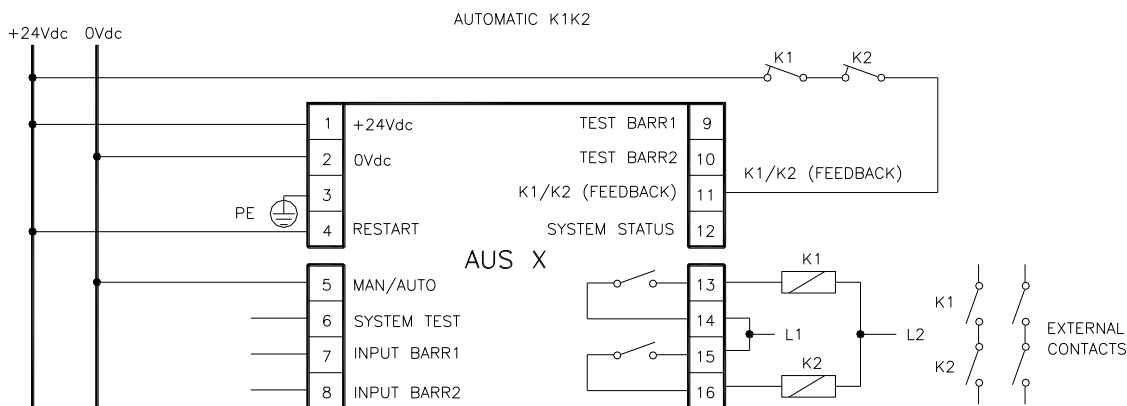

Figure 3

Automatic functioning with K1K2 relays

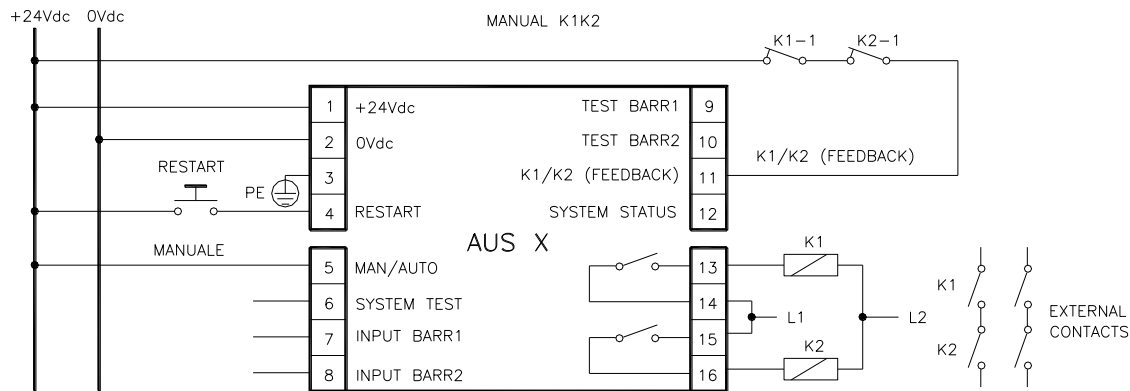

Figure 4
Manual functioning with K1K2 relays

CONNECTON EXAMPLES

CONNECTION OF AUS X WITH 2 COUPLES OF ULISSE/ILION PHOTOCELLS (WITHOUT K1K2 EXTERNAL CONTACTORS)

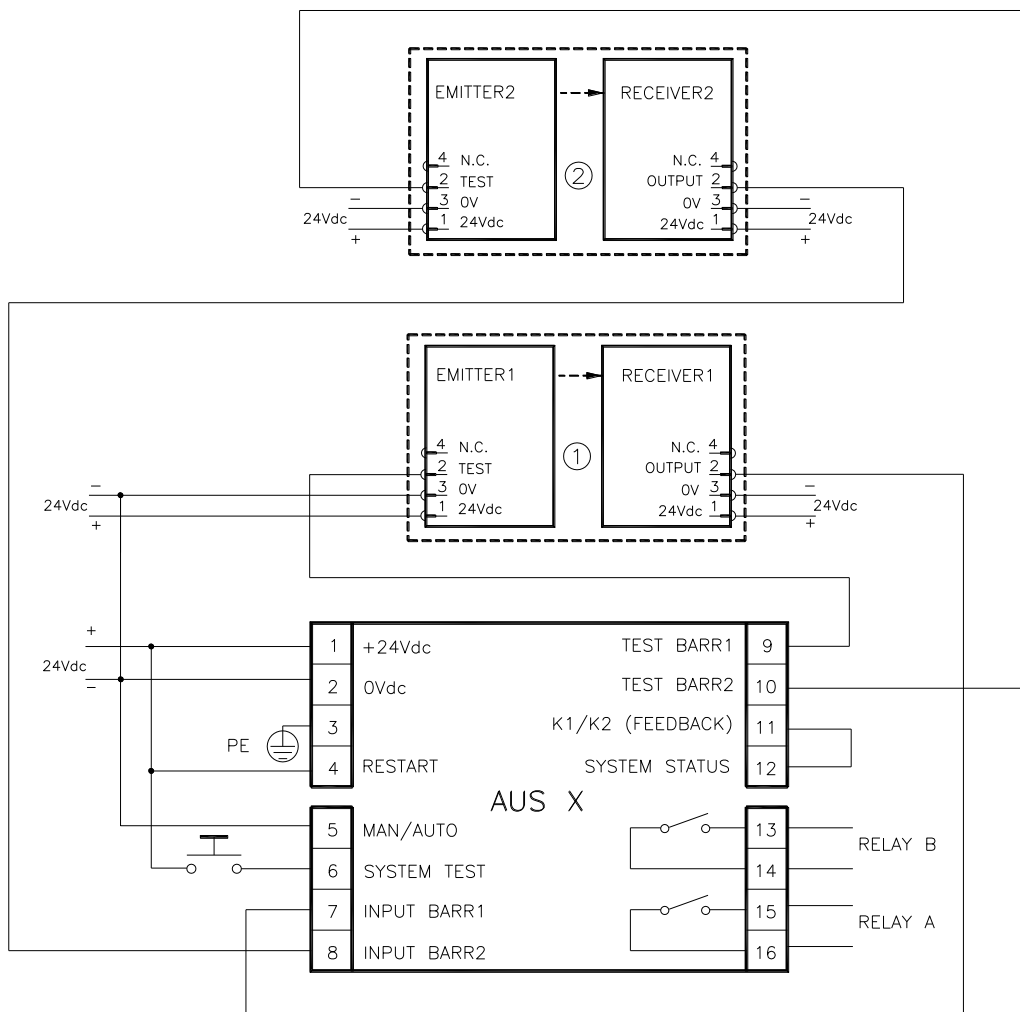

Figure 5

CONNECTION OF AUS X WITH 1 COUPLE OF ULISSE/ILION PHOTOCELLS (WITH K1K2 EXTERNAL CONTACTORS)

MANUAL WITH 1 PHOTOCELLS COUPLE AND K1K2

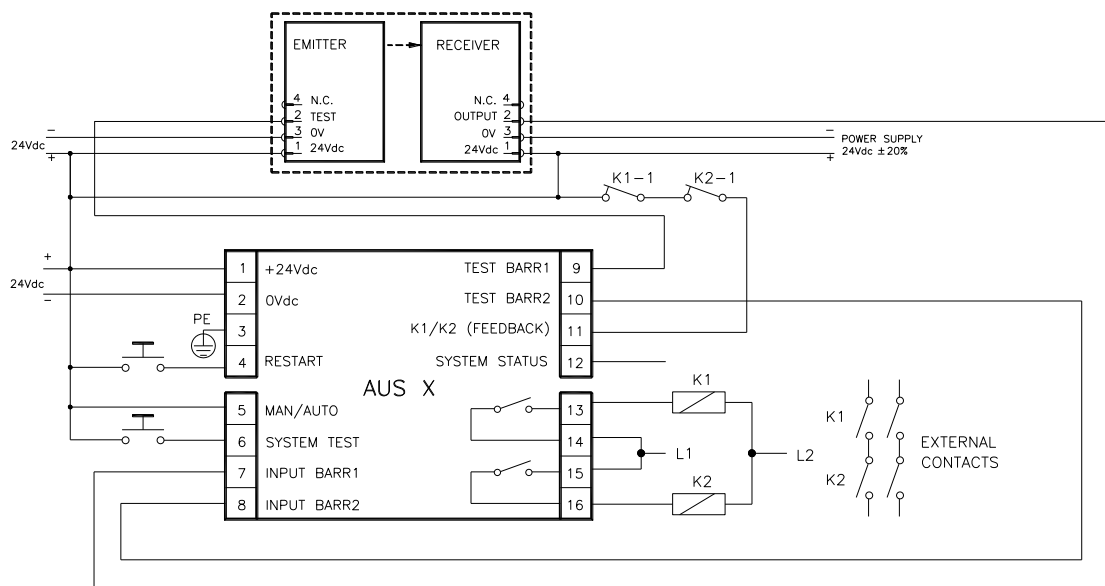

Figure 6

SERIES CONNECTION OF AUS X WITH 2 COUPLES OF ULISSE/ILION PHOTOCELLS (WITH K1K2 EXTERNAL CONTACTORS)

MANUAL WITH 2 PHOTOCELLS COUPLES AND K1K2

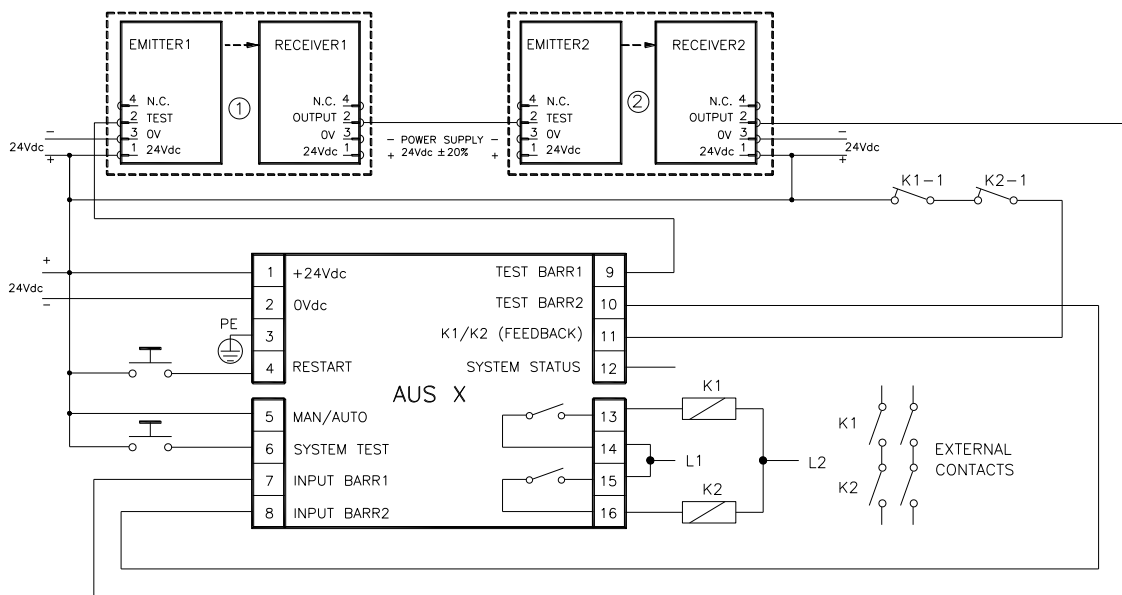

Figure 7

➔ In this case, the 2 photocells are connected in series and the INPUT BARR2 (terminal 8) is not utilized; this signal must be connected to the TEST BARR2 (terminal 10).

**CONNECTION OF AUS X WITH 4 COUPLES OF ULISSE/ILION PHOTOCELLS
(WITHOUT K1K2 EXTERNAL CONTACTORS)**

AUTOMATIC + 4 PHOTOCCELL COUPLES

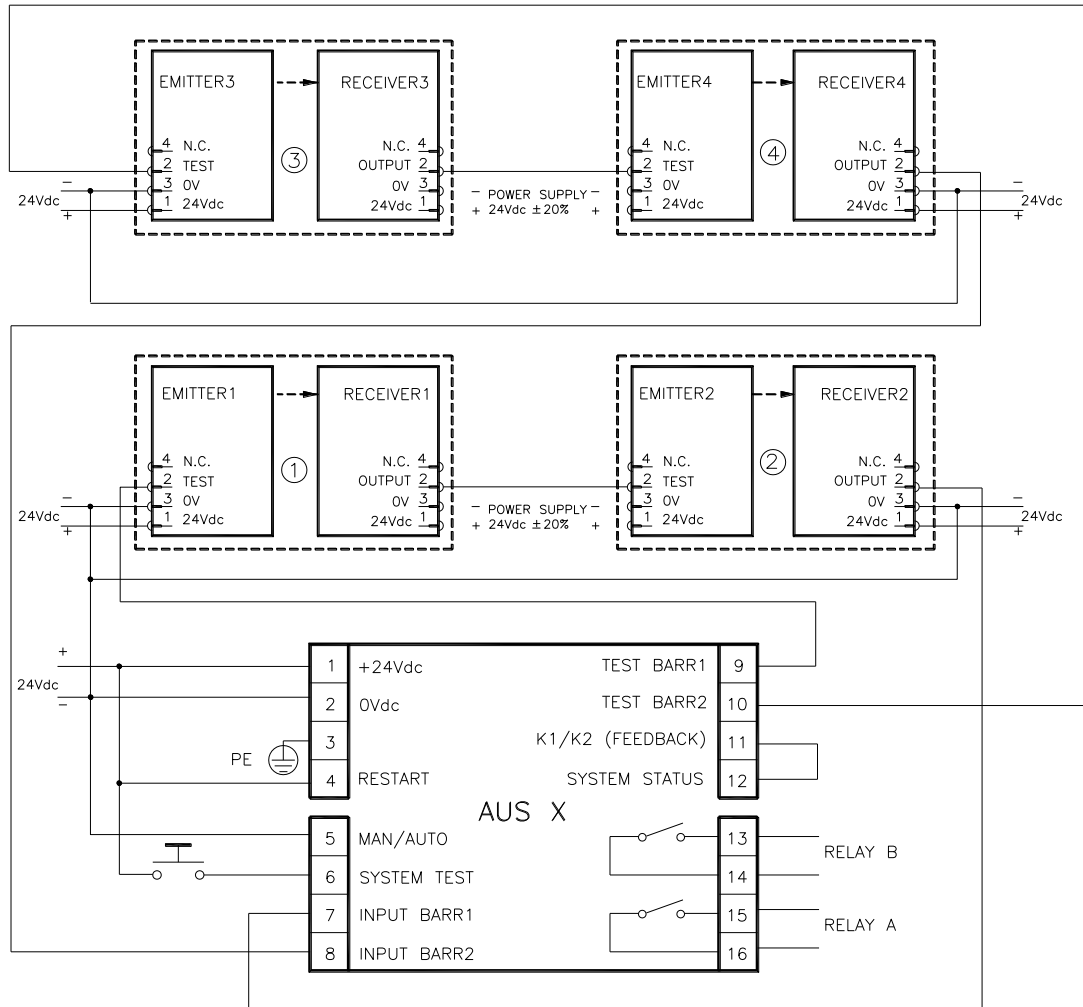



Figure 8

SIGNAL DESCRIPTION

TERMINAL NUMBER	SIGNAL NAME	TYPE OF SIGNAL	DESCRIPTION
1	24VDC		Power supply 24Vdc
2	0VDC		Power supply 0Vdc
3	PE		Ground connection
4	RESTART	Input	Restart command
5	MAN/AUTO	Input	Manual/Automatic Configuration
6	SYSTEM_TEST	Input	Test of the system external request
7	INPUT BARR1	Input	Safety photocell number 1 status input
8	INPUT BARR2	Input	Safety photocell number 2 status input
9	TEST_BARR1	Output	Safety photocell number 1 TEST
10	TEST_BARR2	Output	Safety photocell number 2 TEST
11	K1K2 (Feedback)	Input	Feedback external contactors K1K2
12	SYSTEM STATUS	Output	Output status
13	Relay B NO1	Output	Safety relay B, contact 1 (N.O.)
14	Relay B NO2	Output	Safety relay B, contact 2 (N.O.)
15	Relay A NO1	Output	Safety relay A, contact 1 (N.O.)
16	Relay A NO2	Output	Safety relay A, contact 2 (N.O.)

Table 2**The RESTART command**

- The RESTART command must be sent to the control unit connecting terminal 4 to the +24Vdc.
- The contact used for the RESTART command must be able to switch a voltage of 24Vdc and a current of 20mA (guaranteeing a closing time > 100ms). This data is particularly important in the case of automatic management of the RESTART command sending, for example using a PLC.
- The SYSTEM RESET TIME is obtained adding the reset time of any external contactors K1K2 to the reset time of the AUS X control unit (100ms).
- In the case of manual activation, a normally open external button can be used, temporary closing of which generates the RESTART command.

 The Restart control must be installed outside the danger area in a position where the danger area and the entire work area concerned are clearly visible.

 It must not be possible to reach the control from inside the danger area.

The SYSTEM_TEST command

The SYSTEM_TEST command must be forwarded to the control unit connecting the terminal 6 to the +24Vdc.

The contact used for the SYSTEM_TEST command must be able to switch a current of 20mA and a voltage of 24Vdc (with a switching time of >40ms). The AUS X control unit, after receiving this signal, provides to switch off the emitters of the connected safety photocells, THUS SIMULATING AN INTERCEPTION OF THE PROTECTED AREA.

The operator must verify the effective stopping of the hazardous machine (due to the de-activation of the control unit outputs) for all the time the SYSTEM_TEST command stays active.

 The effective stopping of the system must be verified by an operator and cannot be an operation of the control unit.

K1K2 FEEDBACK input

Using the K1 and K2 auxiliary safety contactors with guided contact safety type, it is necessary to connect the +24Vdc to the K1K2 FEEDBACK through the series of the K1-1 e K2-1 N.C. control contacts. The control of the correct switching of K1 and K2 is performed with a delay of 300ms after the real command.





When the K1-1 e K2-1 N.C. control contacts are not used (or no control is provided) it is mandatory to connect the terminal 11 (K1K2 FEEDBACK) to the terminal 12 (SYSTEM STATUS).

SYSTEM STATUS output

The SYSTEM STATUS output reports exactly the output safety relays status :

- When the output relays are opened, the SYSTEM STATUS reports 0VDC.
- When the output relays are closed, the SYSTEM STATUS reports +24VDC.

INSTALLATION AND ELECTRICAL CONNECTIONS

-  Install the AUS X control unit in an environment with a protection rating of at least IP54.
-  If more modules AUS X must be installed in the same board panel, in order to avoid overheatings, maintain between them one minimal distance of 2cm.
-  The AUS X control unit must be supplied with a 24Vdc ± 20 .
-  The external power supply must comply with the standard EN 60204-1.
-  During the installation of the AUS X control unit be sure to avoid short circuits between the contacts 7 and 8.

Characteristics of the output circuit.

For the output circuit, the control unit uses two guided contact safety relays.

These relays are rated by the manufacturer for voltage and current values above those indicated in the technical data; however, to assure correct insulation and to avoid damage or premature aging, protect each output line with a 4A slow-blow fuse and check that load characteristics comply with the indications given in the table below.

Minimum switching voltage	18 Vdc
Minimum switching current	20 mA
Maximum switching voltage	250Vac
Maximum switching current	2A

Use of K1 and K2 auxiliary contact elements.

For loads with higher voltage and current characteristics than those indicated in the table above, use of auxiliary external relays or contactors suitable for the load to be controlled is recommended.

- The K1 and K2 auxiliary contactors or relays must be of the guided contact safety type.
- Referring to the table below, pay particular attention to the configuration of the control contacts on terminal 11 and that of the contacts of use.

	Relay K1	Relay K2
Control contacts	K1-1 normally closed	K2-1 normally closed
Use contacts	K1-2 normally open	K2-2 normally open

- Control contacts K1-1 and K2-1 (terminal 11) must be able to switch a current of 20mA and a voltage of 24Vdc.
- To increase the electrical life of internal relays A and B, it is advisable to use anti-disturbance devices which must be connected across the coils of K1 and K2.

Warnings regarding the connection cables.

- For light curtain/control unit connections of more than 50m, cables with a cross-section of at least 1mm² must be used.
- It is good practice to separate the power supply of the control unit from that of other electrical appliances (electrical motors, inverters, frequency variators) or other sources of disturbance.
- The path of the connection cables between the control unit and the sensors, the connection referring to the test command and feedback contacts connected to terminal 11 must be different from that of other power cables.

STATUS INDICATORS

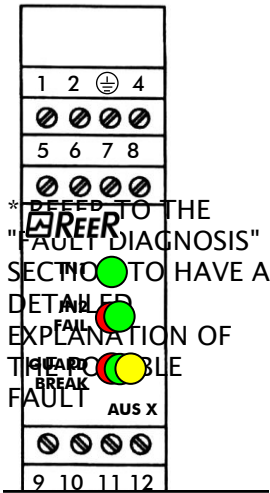

LED	COLOR	STATUS	CONDITION
IN1	Green	ON	Photocell 1 free
		OFF	Photocell 1 intercepted
IN2 FAIL	Green/ Red	RED	Fault detected *
		GREEN	Photocell 2 free
		OFF	Photocell 2 intercepted or absent
GUARD BREAK	Green/ Red/ YELLOW	RED	Output relays opened
		RED blinking	The number of blinkings shows the kind of FAIL (only with IN2/FAIL RED) *
		GREEN	Output relays closed
		YELLOW	Photocells free - Output relays opened (only in manual mode)

DIMENSIONS

Table 3

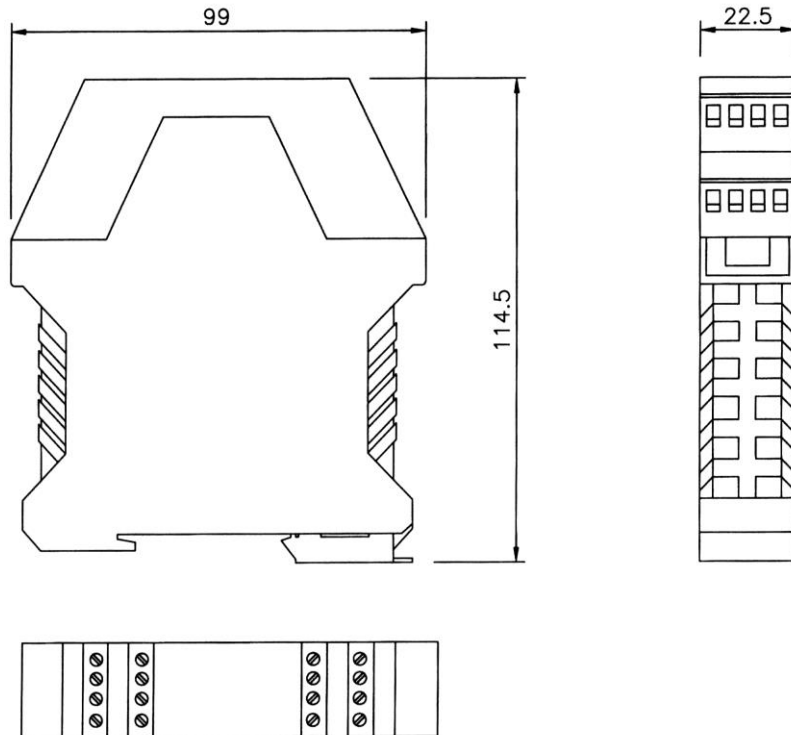

TECHNICAL DATA AUS X

Safety category		2
Power supply	Vdc	24 ± 20%
Power requirement	W	5 max
Output	Relay	2 N.O. contacts (2A; 250V)
System Status Output		100mA; 24Vdc
Response time	ms	30 max
Operating modes		Manual or Automatic, selectable from terminal block
External relay control		2 N.C. contacts (20mA; 24Vdc)
Number of connectable photocells		1 ÷ 4
Connections		Terminal block with protection against reversal of polarity
Status indicators	Led	Power On - Photocell Status - Fail
Max. length of connections	m	100
Operating temperature	°C	0 ÷ 55
Enclosure protection rating		IP 20
Terminal block protection rating		IP 2X
Fastening		Fast attachment to rail according to EN 50022-35
Dimensions (h x w x d)	mm	99 x 22,5 x 114,5
Weight	g	150
B10d		800.000
Device lifetime		20 years
Safety level	Type 2	EN 61496-1:2013
	SILCL 1	IEC 62061(ed.1)
	Cat.2	EN ISO 13849-1:2008

Load	Number of Commutations	PFHd *	DCavg #	MTTFd #	PL #	CCF #
2A@230Vac	1 every 30s	2,64E-08	98,92%	26,04	c	80%
	1 every min	1,55E-08	98,85%	50,18	c	80%
	1 every hour	4,98E-09	97,28%	100,00	c	80%
	1 every day	4,82E-09	96,95%	100,00	c	80%
0,5A@24Vdc	1 every 30s	4,87E-08	98,96%	13,27	c	80%
	1 every min	2,64E-08	98,92%	26,04	c	80%
	1 every hour	5,16E-09	97,54%	100,00	c	80%
	1 every day	4,83E-09	96,97%	100,00	c	80%

Table 4

* IEC 62061

ISO 13849-1

STATUS INDICATORS / FAULT DIAGNOSIS

Status indicators with 1 photocell

LED			MEANING
IN1 GREEN	IN2/FAIL RED/GREEN	GUARD/BREAK RED/GREEN	
ON	RED	RED	Power on TEST
OFF	OFF	RED	Photocell INTERCEPTED, outputs in OFF
ON	OFF	YELLOW	Photocell FREE, outputs in OFF
ON	OFF	GREEN	Photocell FREE, outputs in ON
Shows the photocell_1 status	OFF	YELLOW: blinks 2 times per second	System TEST

Table 5

Status indicators with 2 photocells

LED			MEANING
IN1 GREEN	IN2/FAIL RED/GREEN	GUARD/BREAK RED/GREEN	
ON	RED	RED	Power on TEST
OFF	OFF	RED	Photocell INTERCEPTED, outputs in OFF
OFF	ON	RED	
ON	OFF	RED	
ON	ON	YELLOW	Photocell FREE, outputs in OFF
ON	ON	GREEN	Photocell FREE, outputs in ON
Shows the photocell_1 status	Shows the photocell_2 status	YELLOW: blinking 2 times per second	System TEST

Table 6

FAULT DIAGNOSIS







		LED		MEANING
IN1 GREEN	IN2/FAIL RED/GREEN	GUARD/BREAK RED/GREEN (RED led pulses)		
OFF	ON		(2 pulses)	Possible fault to the Microcontroller board
OFF	ON		(3 pulses)	Internal relays fault
OFF	ON		(4 pulses)	K1K2 external relays fault
OFF	ON		(5 pulses)	User configuration failure
OFF	ON		(6 pulses)	User configuration changed without system restart
OFF	ON		(7 pulses)	Possible overload or SYSTEM STATUS connection error

Table 7

 If it is not possible to clearly identify the malfunction and to remedy it, stop the machine and contact Reer's Assistance Service.

MODULO AUS XM

OPERATING MODES DESCRIPTION

OPERATING MODES SELECTION		
TERMINAL 6	TERMINAL 15	OPERATION
0 Vdc	+24 Vdc	<i>Automatic</i>
+24 Vdc	+24 Vdc through a N.O. contact	<i>Manual</i>
0 Vdc	0 Vdc	<i>Non-permissible conditions</i>
+24 Vdc	+24 Vdc	

Table 8

AUTOMATIC

In this operating mode, the outputs of the control unit follow the status of the photocell:

- with the protected area free (outputs of the photocells active), the relay outputs of the control unit are active.
- with the protected area occupied (outputs of the photocells deactivated), the relay outputs of the control unit are de-activated.

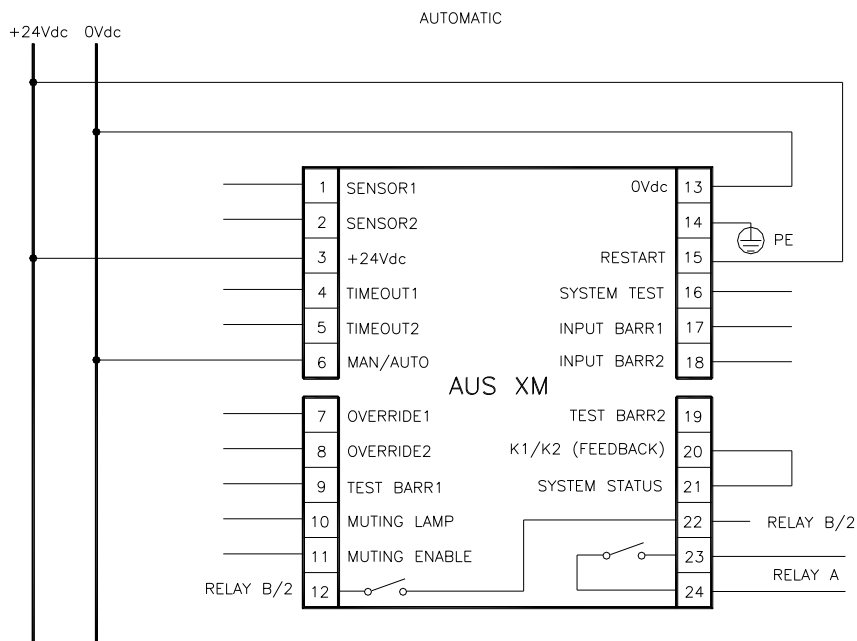

Figure 9

- ☠ Use in manual mode (start/restart interlock activated) is mandatory in the case in which the safety device controls an access protecting a danger zone and once a person has passed through the opening, he/she may remain in the danger zone without being detected (use as trip device according to IEC 61496). Failure to comply with this rule may result in very serious risks for the persons exposed.
- ☠ Check correct functioning of the entire safety system (control unit+photocell) following each re-installation. In particular, if the original operating mode was Manual, check that the unit has been reconfigured in this mode.

MANUAL

In this operating mode, the outputs of the control unit are activated only if the protected area is free and after sending the RESTART signal to the control unit using the push-button or by means of a specific command on the RESTART input (terminal 15).

Once the protected area has been occupied, the relay outputs are deactivated. The sequence described above must be repeated in order to re-activate these.

The RESTART command is active with a 0VDC ---> +24VDC transition. The minimum duration of the command is 100 ms.

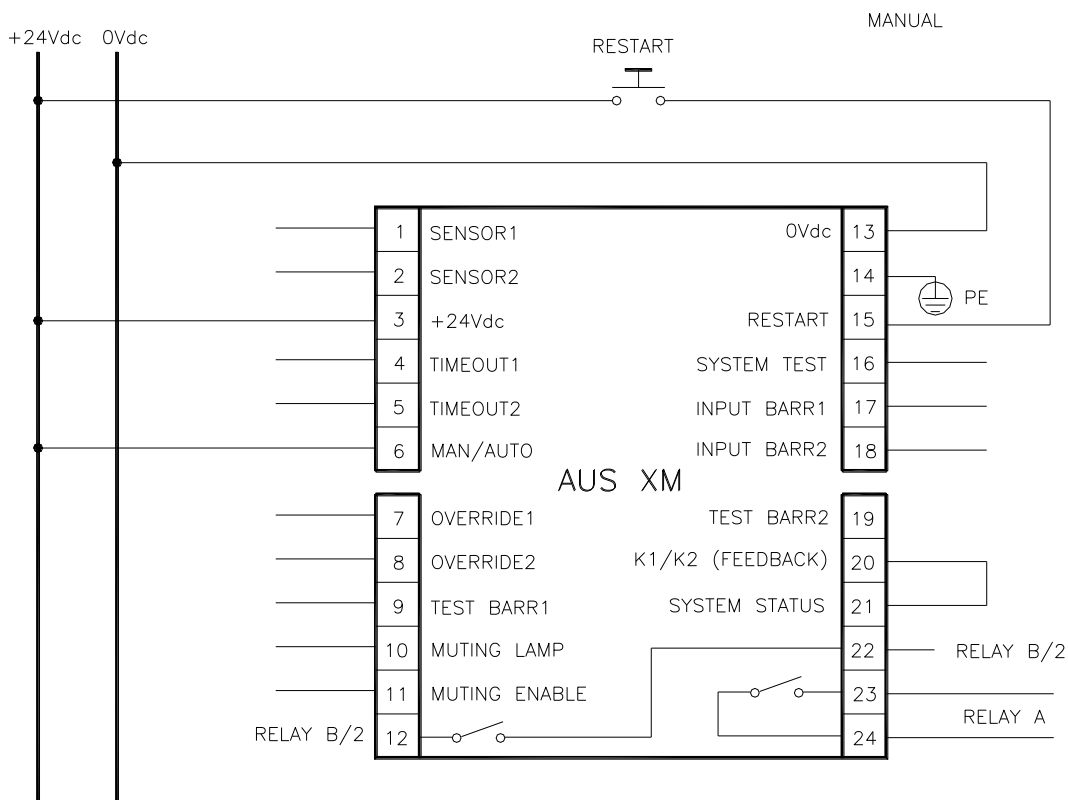

Figure 10

CONNECTION OF EXTERNAL CONTACTORS K1 and K2

Control of external contactors K1K2 can be activated in both operating modes. If this control is to be used, the set of normally closed contacts of the external contactors must be connected to terminal 20 of the control unit (Figure 11 and Figure 12).

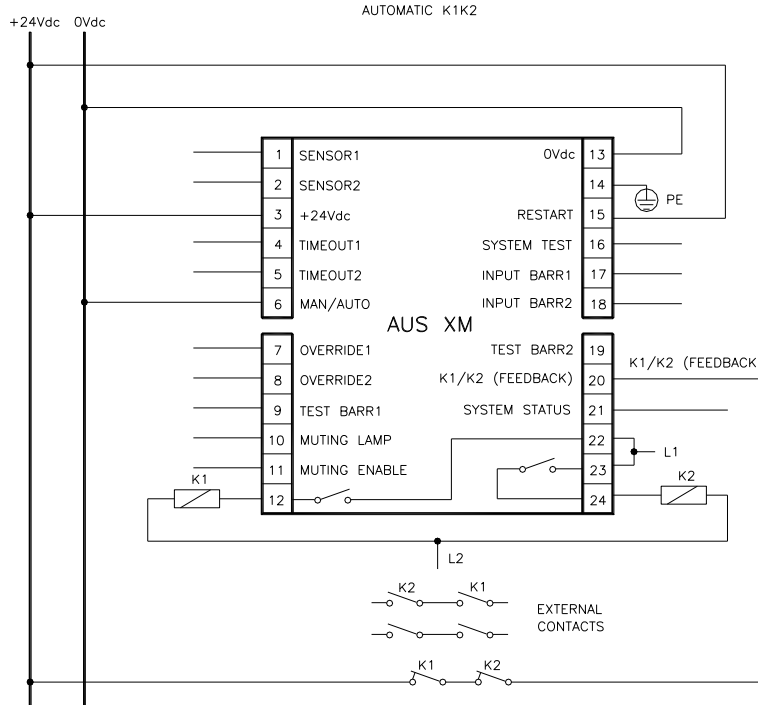

Figure 11
Automatic operation with K1K2 relays

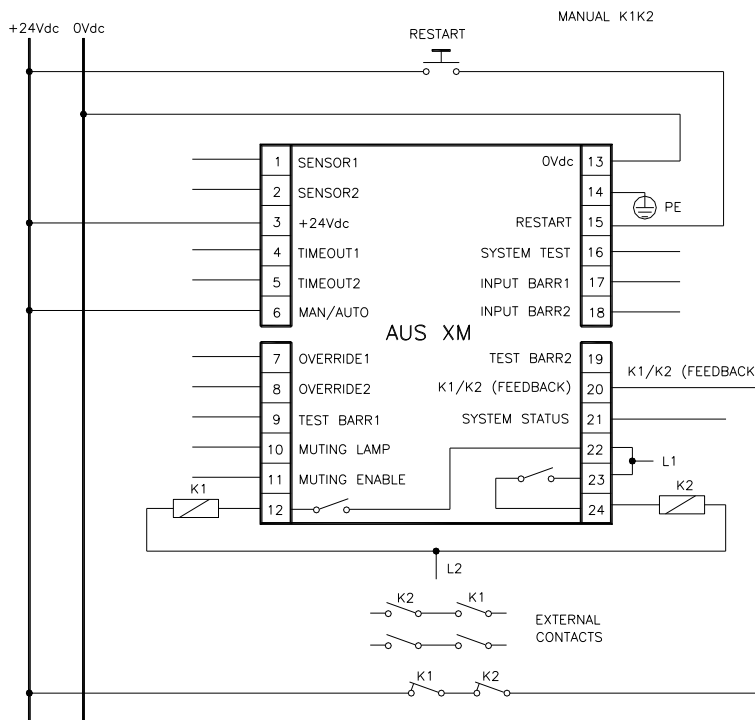

Figure 12
Manual operation with K1K2 relays

CONNECTON EXAMPLES

CONNECTION OF AUS XM WITH 2 COUPLES OF ULISSE/ILION PHOTOCELLS (MANUAL MODE, WITH K1K2 EXTERNAL CONTACTORS, TIMEOUT MUTING = 30s)

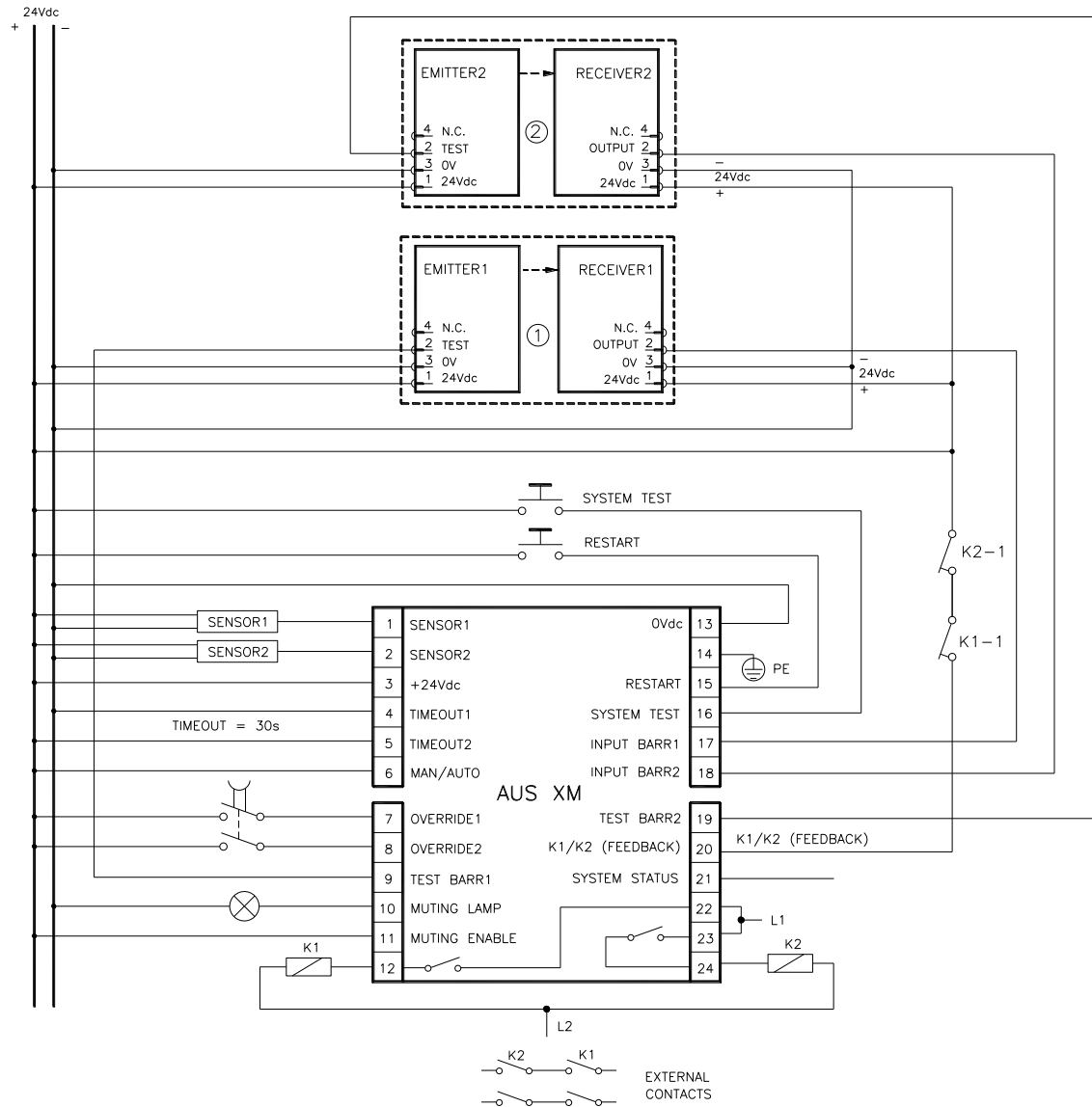

Figure 13

**CONNECTION OF AUS XM WITH 1 COUPLE OF ULISSE/ILION PHOTOCELLS
(MANUAL MODE, WITH K1K2 EXTERNAL CONTACTORS, TIMEOUT MUTING = 30s)**

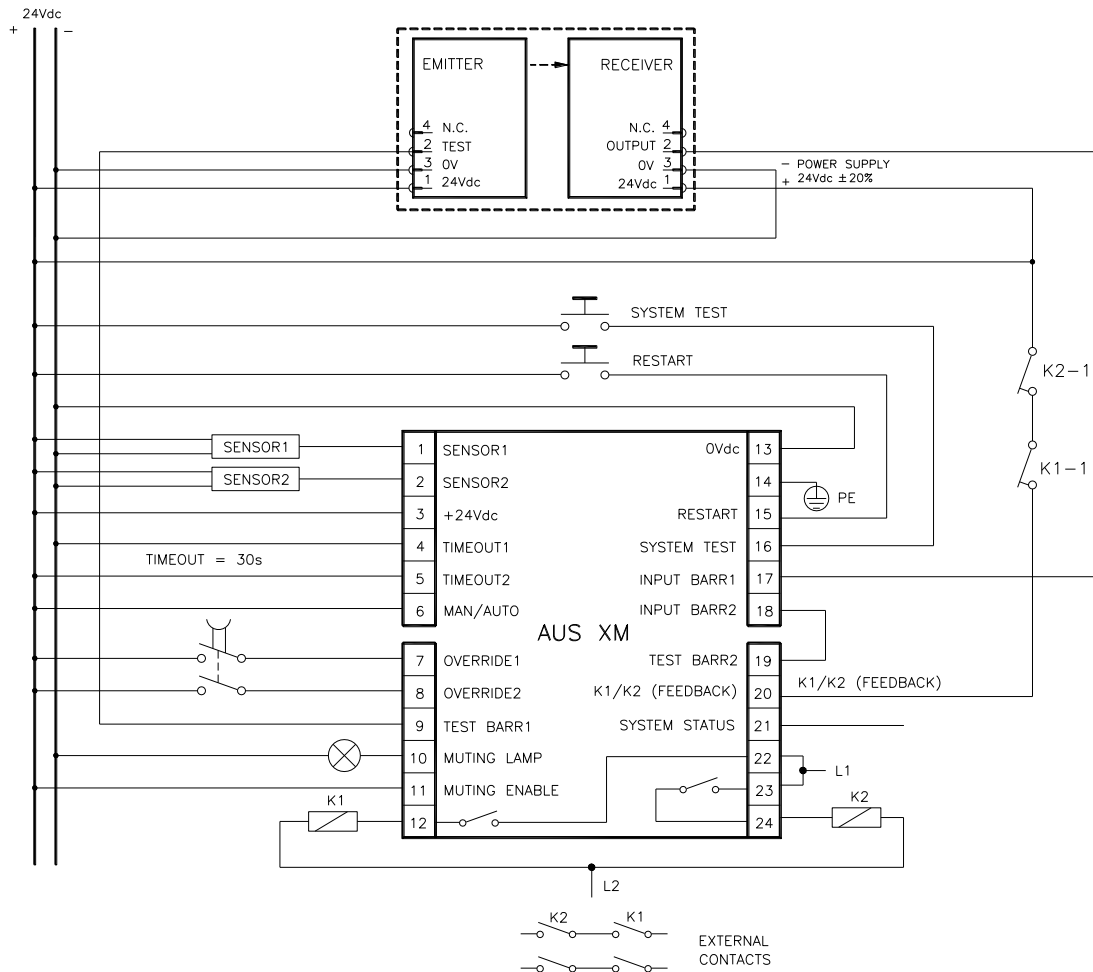

Figure 14

CONNECTION OF AUS XM WITH 2 COUPLES OF ULISSE/ILION PHOTOCELLS IN SERIES (MANUAL MODE, WITH K1K2 EXTERNAL CONTACTORS, TIMEOUT MUTING = 30s)

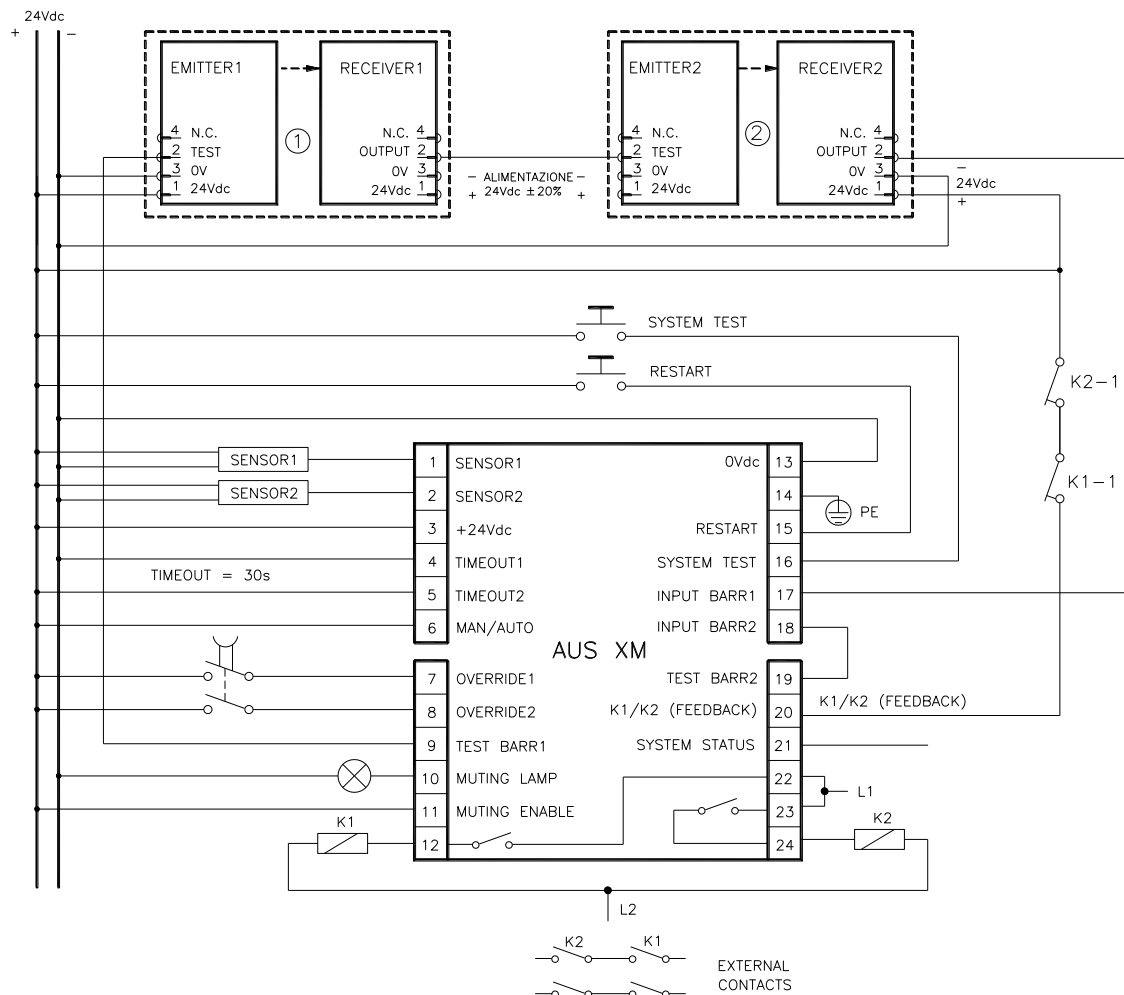

Figure 15

CONNECTION OF AUS XM WITH 4 COUPLES OF ULISSE/ILION PHOTOCELLS IN SERIES (AUTOMATIC MODE, TIMEOUT MUTING = ∞)

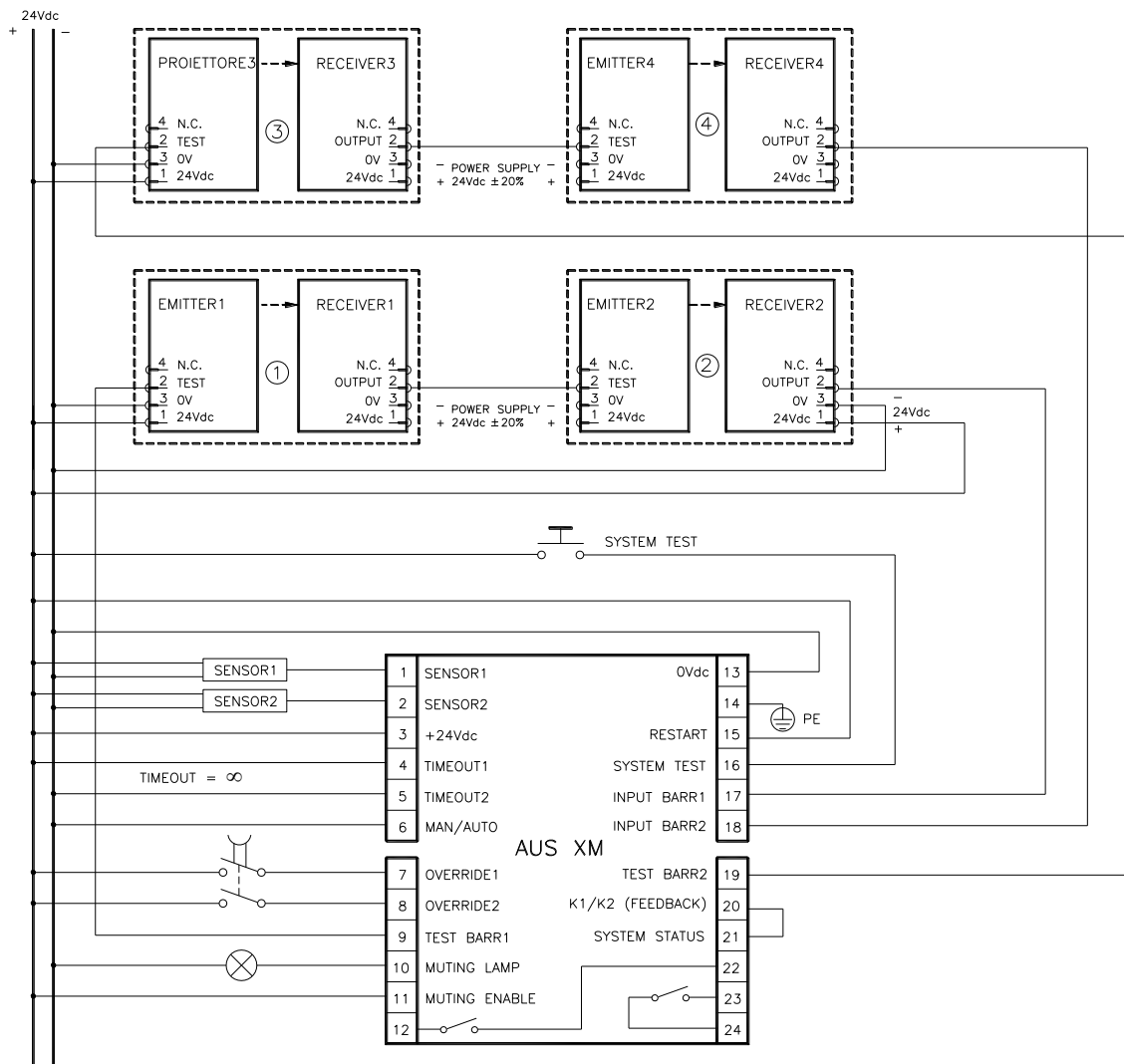

Figure 16

MUTING FUNCTION

⚠ The Muting function is a temporary suspension of the safety light curtain’s protective function. Carefully check your risk analysis in order to assess whether the Muting function is compatible with your application and what additional measures have to be taken.

The Muting function generates a temporary, automatic interruption of the protective function in order to permit normal transit of material through the guarded opening.

The Muting function is activated when the system detects the object that interrupts the opening protected. In other words, when the system recognizes the material and distinguishes between this and any operator (in a potentially dangerous situation), it is enabled to bypass the light curtain temporarily, allowing the material to pass through the opening.

The Muting sensors form the sensing system that decides whether the Muting function is to be activated (or not). Control of the dangerous opening can be de-activated only by a correct sequence of interruption of the beams of the Muting sensors.

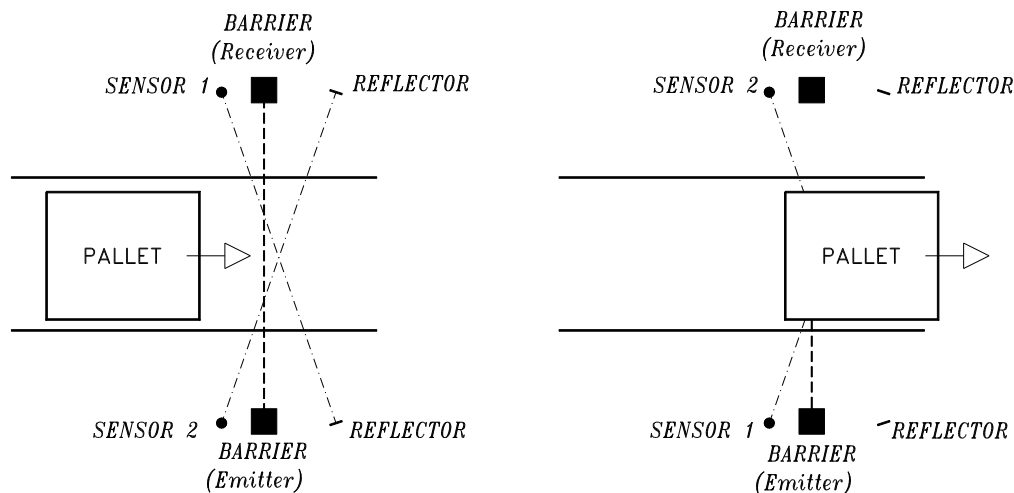

Figure 17
Muting with AUS XM on palletizing system application example

Muting sequence

The timing diagrams in Figure 18 and Figure 19 show the correct signal sequence. The muting function is initiated by the contemporary occurrence of two events :

- When the two beams of the muting sensors are activated within a time limit of 4 sec.
- When the muting enable signal (terminal 11) is high (+24Vdc)

The muting function is terminated by one of the following events:

- As soon as one of the muting sensors is no longer activated whichever occurs first.
- When the muting time-out limit is expired; in this case the OSSDs are brought to the off-state. The muting time-out limit can be selected at 30sec or ∞ .

- ➔ The muting enable command will only enable the muting function and should be generated at the appropriate time by the machine control system(e.g. When the muting function is needed); it has no effect on the deactivation of the muting function. If not used, fix the terminal 11 at +24Vdc.
- ➔ Remember that muting is a temporary automatic suspension of the safety function. This means that a time limit is always mandatory. If a time out limit of 30 sec is a too short time for a particular machine cycle, the configuration without time monitoring ($t = \infty$) can be selected. In this case alternative solutions or additional measures shall be implemented to detected the condition of a muting function permanently active caused by accumulation of faults or by the muting sensors activated all the time. For example for the application of guarding the openings of a conveyor system (palletizers) by monitoring appropriate signals generated by the transport system to determinate if and when a pallet is in the detection zone.

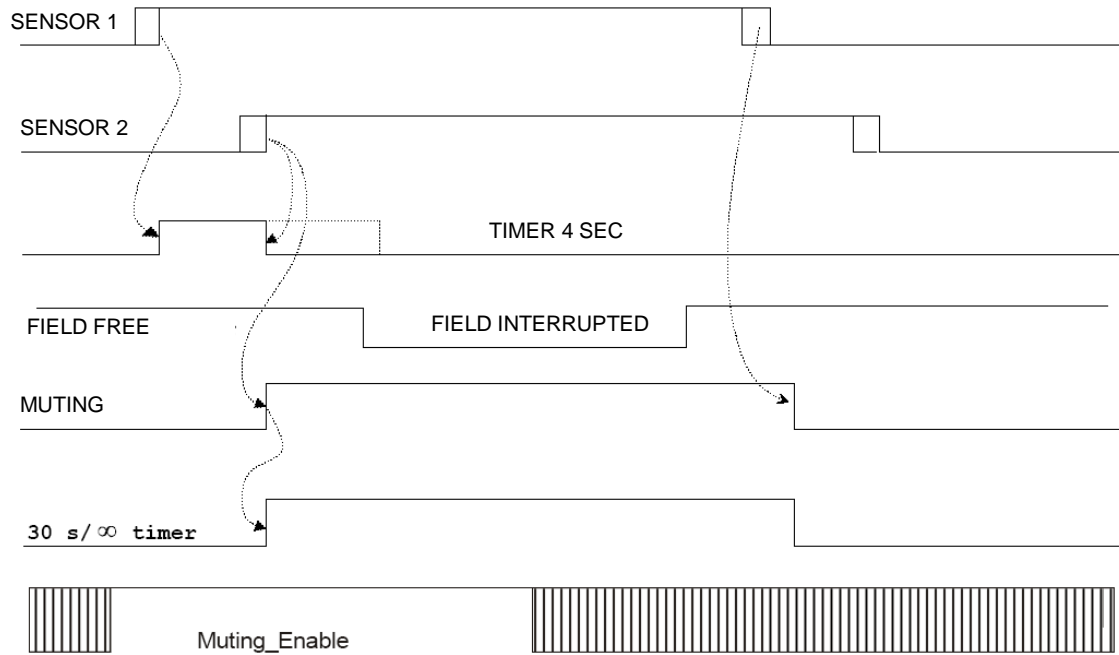

Figure 18 - Muting cycle

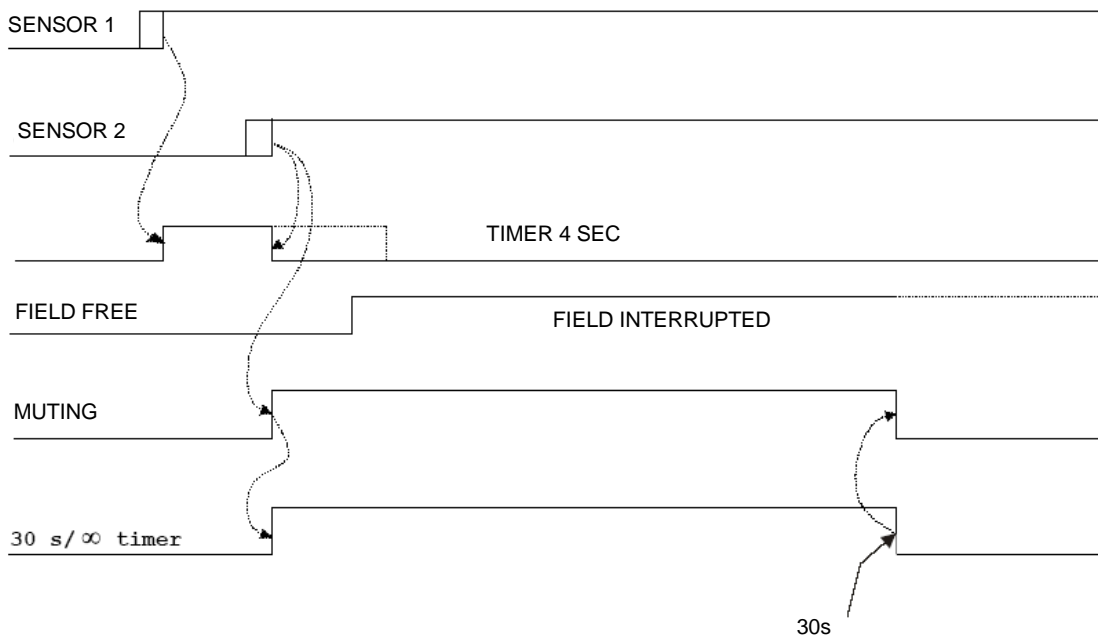





Figure 19 -Muting cycle closed by a timeout

MUTING OVERRIDE FUNCTION

The OVERRIDE function must be used when the machine stops due to incorrect Muting activation sequences with the material obstructing the guarded opening.

In this situation, the OSSD outputs are not active as the photocell and/or at least one Muting sensor is occupied. In this condition the OVERRIDE request led blinks (ref. "Status Indicators").

-  This function activates the OSSD outputs making it possible to remove the material that is obstructing the protected field.
-  Throughout the entire phase during which the OVERRIDE function is active, the Override/Muting light blinks. Check efficiency of this light periodically (during the Muting or Override phases).
-  **Warning!!** The Override with pulse command automatically activates the outputs of the photocell until both the photocell and the muting sensors are free of obstacles again. During this period, the photocell is unable to protect access to the guarded opening. Therefore, all operations must be carried out under the strict supervision of expert personnel.
-  During the installation of the AUS XM control unit be sure to avoid short circuits between the contacts 7 and 8.

The operator will use the Override mode previously selected.



1. Override with maintained action control.
2. Override with pulse control.

Override with maintained action control

This function is activated driving terminals 7 and 8 of the control unit to +24VDC at the same time (maximum delay = 400ms) using for example a 2-way key selector with spring return;

PIN 7	PIN 8	CONDITION
0	0	Normal operation
24VDC	24VDC	OVERRIDE request

The maximum override duration is 15 minutes; it can be stopped for two different causes.

-  When the selector is released or if the 15 minutes has been elapsed, override ends, **de-activating the OSSD outputs, turning off the muting lamp and showing normal condition on the display.** A new override condition can be started, releasing and rearming the selector.
-  Once the opening has been cleared and the sensors are free again, **override ends and GUARD condition (control unit in normal operation) is activated without necessity of further commands.**

Override with pulse control

This function is activated inverting (maximum delay = 400ms) the condition of pin 7 and 8 of the receiver using for example a push button (switch). During the override the 7 and 8 are not controlled.

PIN 7	PIN 8	CONDITION
0	24VDC	Normal operation
24VDC	0	OVERRIDE request

- ➔ The override condition can last a maximum of 15 minutes (repeatable).
- ➔ The function can only be re-started by pressing the pushbutton again (subject to the following conditions):
 1. Maximum total OVERRIDE time (after n consecutive requests) = 60 min
 2. Maximum number of consecutive requests for OVERRIDE = 30.
- ➔ The override condition ends when the barrier and sensors are cleared (entrance clear) and the GUARD condition is re-enabled (barrier fully operational) without sending any further commands.
- ➔ The timer (point 1) and counter (point 2) are reset when one of the following conditions occurs:
 - A correct muting sequence.
 - A system reset (switched off and then turned on).

SIGNALS DESCRIPTION

TERMINAL NUMBER	SIGNAL NAME	TYPE OF SIGNAL	DESCRIPTION
1	SENSOR 1	Input	Muting Sensor n°1
2	SENSOR 2	Input	Muting Sensor n°2
3	24VDC	Input	Power supply 24Vdc
4	TIMEOUT 1	Input	Timeout selection n°1 *
5	TIMEOUT 2	Input	Timeout selection n°2 *
6	MAN/AUTO	Input	Manual/Automatic configuration
7	OVERRIDE 1	Input	Override selection n°1 **
8	OVERRIDE 2	Input	Override selection n°2 **
9	TEST_BARR1	Output	Safety photocell number 1 TEST
10	MUTING LAMP	Output	Muting lamp output
11	MUTING ENABLE	Input	External muting enable input
12	Relay B NO1	Output	Safety relay B, contact 1 (N.O.)
13	0VDC	Input	Power supply 0Vdc
14	PE	-	Ground connection
15	RESTART	Input	Restart command Input
16	SYSTEM_TEST	Input	Test of the system external request
17	INPUT BARR1	Input	Safety photocell number 1 status
18	INPUT BARR2	Input	Safety photocell number 2 status
19	TEST_BARR2	Output	Safety photocell number 2 TEST
20	K1K2 (Feedback)	Input	K1K2 external contactors feedback
21	SYSTEM STATUS	Output	Output safety relays status
22	Relay B NO2	Output	Safety relay B, contact 2 (N.O.)
23	Relay A NO1	Output	Safety relay A, contact 1 (N.O.)
24	Relay A NO2	Output	Safety relay A, contact 2 (N.O.)

Table 9

* REFER TO THE Table 10 FOR THE SELECTION OF THE MUTING TIMEOUT

Read carefully the "Muting sequence" section to select the right timeout

SELECTION OF THE MUTING TIMEOUT		
TERMINAL 4	TERMINAL 5	TIMEOUT
0 Vdc	+24 Vdc	30s
+24 Vdc	0 Vdc	Infinite
0 Vdc	0 Vdc	Conditions not allowed
+24 Vdc	+24 Vdc	

Table 10

** REFER TO THE Table 11 FOR THE SELECTION OF THE OVERRIDE

SELECTION OF THE OVERRIDE		
TERMINAL 7	TERMINAL 8	OVERRIDE MODE
0 Vdc	0 Vdc	Spring return key
0 Vdc	+24 Vdc	Push button
+24 Vdc	0 Vdc	Conditions not allowed
+24 Vdc	+24 Vdc	

Table 11

The RESTART command

- The RESTART command must be sent to the control unit connecting terminal 15 to the +24Vdc.
- The contact used for the RESTART command must be able to switch a voltage of 24Vdc and a current of 20mA (guaranteeing a closing time > 100ms). This data is particularly important in the case of automatic management of sending of the RESTART command, for example using a PLC.
- The SYSTEM RESET TIME is obtained adding the reset time of any external contactors K1K2 to the reset time of the AUS XM control unit (100ms).
- In the case of manual activation, a normally open external button can be used, temporary closing of which generates the RESTART command.

- ⚠ The Restart command must be installed outside the danger area in a position where the danger area and the entire work area concerned are clearly visible.
 - ⚠ It must not be possible to reach the control from inside the danger area.

The SYSTEM_TEST command

The SYSTEM_TEST command must be forwarded to the control unit connecting the terminal 16 to the +24Vdc.

The contact used for the SYSTEM_TEST command must be able to switch a current of 20mA and a voltage of 24Vdc (with a switching time of > 40ms). The AUS X control unit, after receiving this signal, provides to switch off the emitters of the connected safety photocells, THUS SIMULATING AN INTERCEPTION OF THE PROTECTED AREA.

The operator must verify the effective stopping of the hazardous machine (due to the de-activation of the control unit outputs) for all the time the SYSTEM_TEST command stays active.

- ⚠ The effective stopping of the system must be verified by an operator and cannot be an operation of the control unit.

K1K2 FEEDBACK input

Using the K1 and K2 auxiliary safety contactors with guided contact safety type, it is necessary to connect the +24Vdc to the K1K2 FEEDBACK through the series of the K1-1 e K2-1 N.O. control contacts. The control of the correct switching of K1 and K2 is performed with a delay of 300ms after the real command.





When the K1-1 e K2-1 N.O. control contacts are not used (or no control is provided) it is mandatory to connect the terminal 20 (K1K2 FEEDBACK) to the terminal 21 (SYSTEM STATUS).

SYSTEM STATUS output

The SYSTEM STATUS output reports exactly the output safety relays status :

- When the output relays are opened, the SYSTEM STATUS reports 0VDC.
- When the output relays are closed, the SYSTEM STATUS reports +24VDC.

INSTALLATION AND ELECTRICAL CONNECTIONS

-  Install the AUS XM control unit in an environment with a protection rating of at least IP54.
-  If more modules AUS XM must be installed in the same board panel, in order to avoid overheating, maintain between them one minimal distance of 2cm.
-  The AUS XM control unit must be supplied with a 24Vdc ±20.
-  The external power supply must comply with the standard EN 60204-1.
-  During the installation of the AUS XM control unit be sure to avoid short circuits between the contacts 17 and 18.

Characteristics of the output circuit.

For the output circuit, the control unit uses two guided contact safety relays.

These relays are rated by the manufacturer for voltage and current values above those indicated in the technical data; however, to assure correct insulation and to avoid damage or premature aging, protect each output line with a 4A slow-blow fuse and check that load characteristics comply with the indications given in the table below.

Minimum switching voltage	18 Vdc
Minimum switching current	20 mA
Maximum switching voltage	250Vac
Maximum switching current	2A

Use of K1 and K2 auxiliary contact elements.

For loads with higher voltage and current characteristics than those indicated in the table above, use of auxiliary external relays or contactors suitable for the load to be controlled is recommended.

- The K1 and K2 auxiliary contactors or relays must be of the guided contact safety type.
- Referring to the table below, pay particular attention to the configuration of the control contacts on terminal 20 and that of the contacts of use.

	Relay K1	Relay K2
Control contacts	K1-1 normally closed	K2-1 normally closed
Use contacts	K1-2 normally open	K2-2 normally open

- Control contacts K1-1 and K2-1 (terminal 20) must be able to switch a current of 20mA and a voltage of 24Vdc.
- To increase the electrical life of internal relays A and B, it is advisable to use anti-disturbance devices which must be connected across the coils of K1 and K2.

Warnings regarding the connection cables.

- For light curtain/control unit connections of more than 50m, cables with a cross-section of at least 1mm² must be used.
- It is good practice to separate the power supply of the control unit from that of other electrical appliances (electrical motors, inverters, frequency variators) or other sources of disturbance.
- The path of the connection cables between the control unit and the sensors, the connection referring to the test command and feedback contacts connected to terminal 20 must be different from that of other power cables.

STATUS INDICATORS

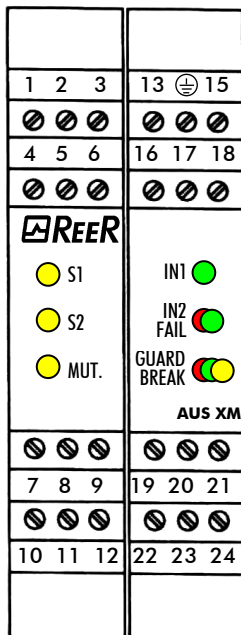

LED	COLOR	STATUS	DESCRIPTION
S1	YELLOW	OFF	Muting sensor 1 free
		ON	Muting sensor 1 interrupted
S2	YELLOW	OFF	Muting sensor 2 free
		ON	Muting sensor 2 interrupted
MUT	YELLOW	OFF	Correct operation
		ON	Muting active
		blinking	<ul style="list-style-type: none"> • Override request • Muting fail (only with FAIL led ON) *
IN1	Green	OFF	Photocell 1 interrupted
		ON	Photocell 1 free
IN2 FAIL	Green Red	OFF	Photocell 2 interrupted
		GREEN	Photocell 2 free
		RED	Failure detected *
GUARD BREAK	Green Red YELLOW	GREEN	Output relays closed
		RED	Output relays opened
		RED blinking	The number of blinkings shows the kind of FAIL (only with IN2/FAIL RED) *
		YELLOW	Photocells free - Output relays opened (only in manual operative mode)

Table 12

* REFER TO THE "FAULT DIAGNOSIS" SECTION TO HAVE A DETAILED EXPLANATION OF THE POSSIBLE FAULT

DIMENSIONS

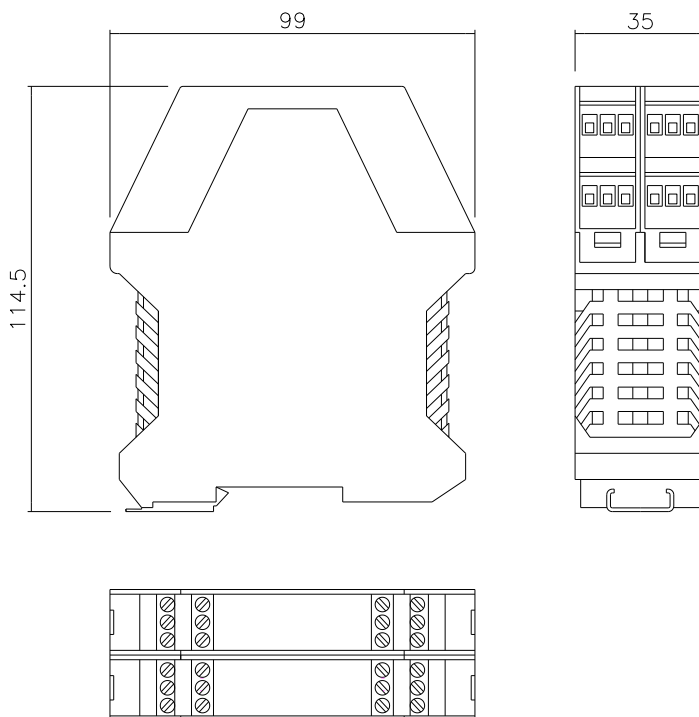

Figure 20

TECHNICAL DATA

Safety category		2
Power supply	Vdc	24 ± 20%
Power requirement	W	5 max
Output	Relay	2 N.O. contacts (2A; 250V)
System Status Output		100mA; 24Vdc
Muting lamp output		24Vdc / 0,5 ÷ 5 W
Response time	ms	30 max
Operating modes		Manual or Automatic, selectable from terminal block
External relay control		2 N.C. contacts (20mA; 24Vdc)
Number of connectable photocells		1 ÷ 4
Muting sensors input		2 sens. (24VDC; PNP; dark-on)
Muting enable input		24VDC, PNP
Connections		Terminal block with protection against reversal of polarity
Status indicators	Led	Power On - Photocell Status - Fail - Muting active - Override active
Max. length of connections	m	100
Operating temperature	°C	0 ÷ 55
Enclosure protection rating		IP 20
Terminal block protection rating		IP 2X
Fastening		Fast attachment to rail according to EN 50022-35
Dimensions (h x w x d)	mm	99 x 35 x 114,5
Weight	g	215
B10d		800.000
Device lifetime		20 years
Safety level	Type 2	EN 61496-1:2013
	SILCL 1	IEC 62061(ed.1)
	Cat.2	EN ISO 13849-1:2008

Load	Number of Commutations	PFHd *	MTTFd #	DCavg #	PL #	CCF #
2A@230Vac	1 every 30s	2,81E-08	25,94	98,89%	C	80%
	1 every min	1,72E-08	49,82	98,78%	C	80%
	1 every hour	6,63E-09	100,00	96,73%	C	80%
	1 every day	6,47E-09	100,00	96,32%	C	80%
0,5A@24Vdc	1 every 30s	5,03E-08	13,24	98,94%	C	80%
	1 every min	2,81E-08	25,94	98,89%	C	80%
	1 every hour	6,81E-09	100,00	97,05%	C	80%
	1 every day	6,48E-09	100,00	96,36%	C	80%

* IEC 62061

ISO 13849-1

STATUS INDICATORS / FAULT DIAGNOSIS

Status indicators with 1 photocell connected

LED			MEANING
IN1 GREEN	IN2/FAIL RED/GREEN	GUARD/BREAK RED/GREEN	
ON	RED	RED	Power up test
OFF	OFF	RED	Photocell interrupted Output relays opened
ON	OFF	YELLOW	Photocell free Output relays opened
ON	OFF	GREEN	Photocell free Output relays closed
System test	OFF	YELLOW: blinking 2 times per second	System test

Table 13

Status indicators with 2 photocells connected

LED			MEANING
IN1 (GREEN)	IN2/FAIL (RED/GREEN)	GUARD/BREAK (RED/GREEN)	
ON	RED	RED	Power up test
OFF	OFF	RED	Photocell interrupted Output relays opened
OFF	GREEN	RED	
ON	OFF	RED	
ON	GREEN	YELLOW	Photocell free Output relays opened
ON	GREEN	GREEN	Photocell free Output relays closed
Shows the photocell_1 status	Shows the photocell_2 status	YELLOW: blinking 2 times per second	System test

Table 14

Status indicators (MUTING module)

LED			MEANING
S1 (YELLOW)	S2 (YELLOW)	MUTING (YELLOW)	
ON	ON	ON	Power up test
OFF	OFF	OFF	Both the sensors are free
ON	OFF	OFF	Sensor 1 interrupted
OFF	ON	OFF	Sensor 2 interrupted
ON	ON	ON	Muting active
Shows the sensor_1 status	Shows the sensor_2 status	Blinking	Override request

Table 15

Fault diagnosis







LED			MEANING
IN1 GREEN	IN2/FAIL RED/GREEN	GUARD/BREAK RED/GREEN (RED led pulses)	
OFF	ON	 (2 pulses)	Possible fault to the Microcontroller board
OFF	ON	 (3 pulses)	Internal relays fault
OFF	ON	 (4 pulses)	K1K2 external relays fault
OFF	ON	 (5 pulses)	User configuration failure
OFF	ON	 (6 pulses)	User configuration changed without system restart
OFF	ON	 (7 pulses)	Possible overload or SYSTEM STATUS connection error

Table 16**Fault diagnosis (modulo MUTING)**





LED			MEANING
S1 YELLOW	S2 YELLOW	MUTING YELLOW	
OFF	OFF	 (2 pulses)	Bad connection of the muting lamp, lamp not present or in overload
OFF	OFF	 (3 pulses)	Muting timeout wrong configuration
OFF	OFF	 (4 pulses)	Wrong override configuration at the power up
Shows the sensor_1 status	Shows the sensor_2 status	 (5 pulses)	Instable muting Sensor
Blinking	Blinking	Blinking	Override with pulse command expired

Table 17

 If it is not possible to clearly identify the malfunction and to remedy it, stop the machine and contact Reer's Assistance Service.

GUARANTEE

ReeR warrants that each AUS X - AUS XM unit in new ex-factory condition, in conditions of normal use, is free of defects in the materials and of manufacturing defects for a period of 12 (twelve) months.

In this period, ReeR undertakes to eliminate any faults in the product through repair or replacement of the faulty parts, completely free of charge as regards material and labor.

However, ReeR reserves the right to replace the entire faulty appliance with another equivalent appliance or with the same characteristics instead of repairing this.

Validity of this warranty is regulated by the following conditions:

- The user must inform ReeR of the fault within twelve months from the date of delivery of the product.
- The appliance and its components must be in the conditions in which they were delivered by ReeR.
- The serial numbers must be clearly legible.
- The fault or defect has not been caused directly or indirectly by:
 - Improper use;
 - Non-compliance with instructions for use;
 - Carelessness, inexperience, incorrect maintenance;
 - Repairs, modifications, adaptations not carried out by ReeR personnel, tampering, etc.;
 - Accidents or impacts (also due to transportation or causes of force majeure);
 - Other causes not to be ascribed to ReeR.

Repairs will be carried out at the ReeR laboratories to which the material must be delivered or dispatched: transport risks and the risks of any damage or loss of the material during shipment are the responsibility of the user.

All products and components replaced become the property of ReeR.

ReeR does not recognize any other warranties or rights except for those specifically described above; therefore, no claims for damages may be submitted for expenses, interruption of business or other factors or circumstances in any way related to failure of the product or of one of its parts.

Precise, complete compliance with all the rules, instructions and prohibitions indicated in this handbook is an essential requirement for correct functioning of the control unit. ReeR s.p.a. therefore declines any responsibility for all and anything resulting from failure to comply, even partially, with such indications.

Characteristics subject to change without notice. • Total or partial reproduction is forbidden without the prior authorization of ReeR.



Dichiarazione CE di conformità
EC declaration of conformity

Torino, 15/05/2020

REER SpA
via Carcano 32
10153 – Torino
Italy

dichiara che l'unità di controllo AUS X/AUS XM/AUS X-ZH/AUS XM-ZH unitamente ad un numero variabile da 1 a 4 sensori di sicurezza della serie ULISSE UPC o ILION costituisce un sistema Elettrosensibile di Sicurezza (ESPE) di:

- **Tipo 2** (secondo la Norma EN 61496-1:2013)
- **SILCL 1** (secondo la Norma EN 62061:2005/A2:2015)
- **PL c** (secondo la Norma EN ISO 13849-1:2015)

declares that the control unit AUS X/AUS XM/AUS X-ZH/AUS XM-ZH together with 1,2,3 or 4 ULISSE UPC or ILION series safety sensors forms a type 2 Electro-sensitive Protective Equipment (ESPE) of :

- **Type 2** (according the Standard EN 61496-1:2013)
- **SILCL 1** (according the Standard EN 62061:2005/A2:2015)
- **PL c** (according the Standard EN ISO 13849-1:2015)

realizzati in conformità alle seguenti Direttive Europee:
complying with the following European Directives:

- **2006/42/EC** "Direttiva Macchine"
"Machine Directive"
- **2014/30/EU** "Direttiva Compatibilità Elettromagnetica"
"Electromagnetic Compatibility Directive"
- **2011/65/EU** "Limitazioni sull'uso di sostanze pericolose nelle Apparecchiature Elettriche ed Elettroniche"
"Restriction of the use of certain hazardous substances in Electrical and Electronic Equipment"

e alle seguenti Norme: /and to the following Standards:

- **EN 50178: 1997**
- **EN 55022: 2006**
- **EN 61000-6-2: 2005**

e sono identiche all'esemplare esaminato ed approvato con esame di tipo CE da:
and are identical to the specimen examined and approved with a CE - type approval by:

TÜV SÜD Product Service GmbH – Zertifizierstelle – Ridlerstraße 65 – 80339 – München – Germany
N.B. number: 0123 – Certificate No. Z10 024820 0078 Rev. 00

Carlo Pautasso
Direttore Tecnico
Technical Director

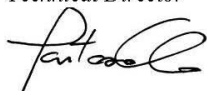

Simone Scaravelli
Amministratore Delegato
Managing Director





Via Carcano, 32
10153 Torino, Italy
T +39 011 248 2215
F +39 011 859 867
www.reersafety.com
info@reer.it

All REER product manuals are available at URL

