

Installation Instructions

Safety Speed Monitor

SV MRO U



(Original instructions)



Contents

Preliminary note	3
Symbols used	3
Safety instructions	4
General requirements on the safety-related functions	4
Operation	5
General function description	5
Switching function: UNDer speed	5
Hysteresis.....	6
Initialisation.....	6
Installation.....	7
Mechanical installation of the device	7
Electrical Connections	8
Terminals	8
Set up of the device	9
Automatic/Manual mode selections	13
Enable input:	16
Technical data SV MRO U	17
Definition of the LED's	18
Faults (blinkings)	18
Additional notes	19
Pulse inputs, pulse pick-ups	19
Switching outputs:	19
Restart command:.....	19
Fault output:.....	19
UNDer speed output:	19
Feedback circuit:.....	19
Checklist after installation.....	19
Warranty.....	20

PRELIMINARY NOTE

The instructions are part of the unit. They are intended for authorised persons according to the EMC and Low Voltage Directive and safety regulations.

The instructions contain information about the correct handling of the product. Read the instructions before use to familiarise yourself with operating conditions, installation and operation. Adhere to the safety instructions.

SYMBOLS USED

▶ Instructions

> Reaction, result

→ *Cross-reference*



This safety alert symbol indicates a potential personal safety hazard. Failure to comply with instructions bearing this symbol could pose a very serious risk to personnel.



Information
Supplementary note.

Safety instructions

Follow the operating instructions.

- Improper use may result in malfunctions of the unit. This can lead to personal injury and/or damage to property during operation of the machine. For this reason note all remarks on installation and handling given in these instructions. Also adhere to the safety instructions for the operation of the whole installation.
- In case of non-observance of notes or standards, specially when tampering with and/or modifying the unit, any liability and warranty is excluded.
- The unit must be installed, connected and put into operation by a qualified electrician trained in safety technology.
- The applicable technical standards for the corresponding application must be complied with.
- For installation the requirements according to EN 60204 must be observed.
- Connect and lay all cables according to EN ISO 13849-2 D.5.2 (Safety of machinery - Safety-related parts of control systems).
- In case of malfunction of the unit please contact the manufacturer. Tampering with the unit is not allowed.
- Disconnect the unit externally before handling it. Also disconnect any independently supplied relay load circuits.
- After setup the system has to be subjected to a complete function check.
- Use the unit only in specified environmental conditions (→ Technical data). In case of special operating conditions please contact the manufacturer.
- Use only as described below.

GENERAL REQUIREMENTS ON THE SAFETY-RELATED FUNCTIONS

The device complies with the functional and organisational requirements of EN ISO 13849-1 Performance-Level "e" and of EN 62061 SIL "3".



To maintain Safety Integrity Level (SIL) "3" requirements the two input sensors shall be independent.

Common cause failures between measuring sensors must be excluded by observing an appropriate cable installation (i.e. separate cable paths).



To maintain the category 4 requirements during longer periods of standstill, a forced dynamisation (t<24h) has to be carried out.

Operation

GENERAL FUNCTION DESCRIPTION

The speed monitor is a two-channel pulse evaluation system for safe underspeed detection.

To do so, it receives the pulse sequences from the pulse pick-ups connected to the inputs. The module calculate the resulting frequency.

By continuously comparing the input frequency (actual value) and the switch point (preset value) the evaluation system promptly detects underspeed of the set switch point, and the output relays switch according to the preset switching function.

The preset value is achieved by setting the 3 switches located in front of the module.

The value can be set in “rpm” or “Hz” unit.

The device complies with the functional and organisational requirements of EN ISO 13849-1 Performance-Level "e" and of EN 62061 SIL "3".

SWITCHING FUNCTION: UNDERSPEED

The output relays energise when the event occurs (10 seconds timer activated).

The relays remain ON again until the frequency value is greater than the selected values. The NO contacts of the internal relays are connected in "series" and connected to the terminals. If both relays are energised, the current paths are closed so that (e.g.) a power contactor can be controlled.

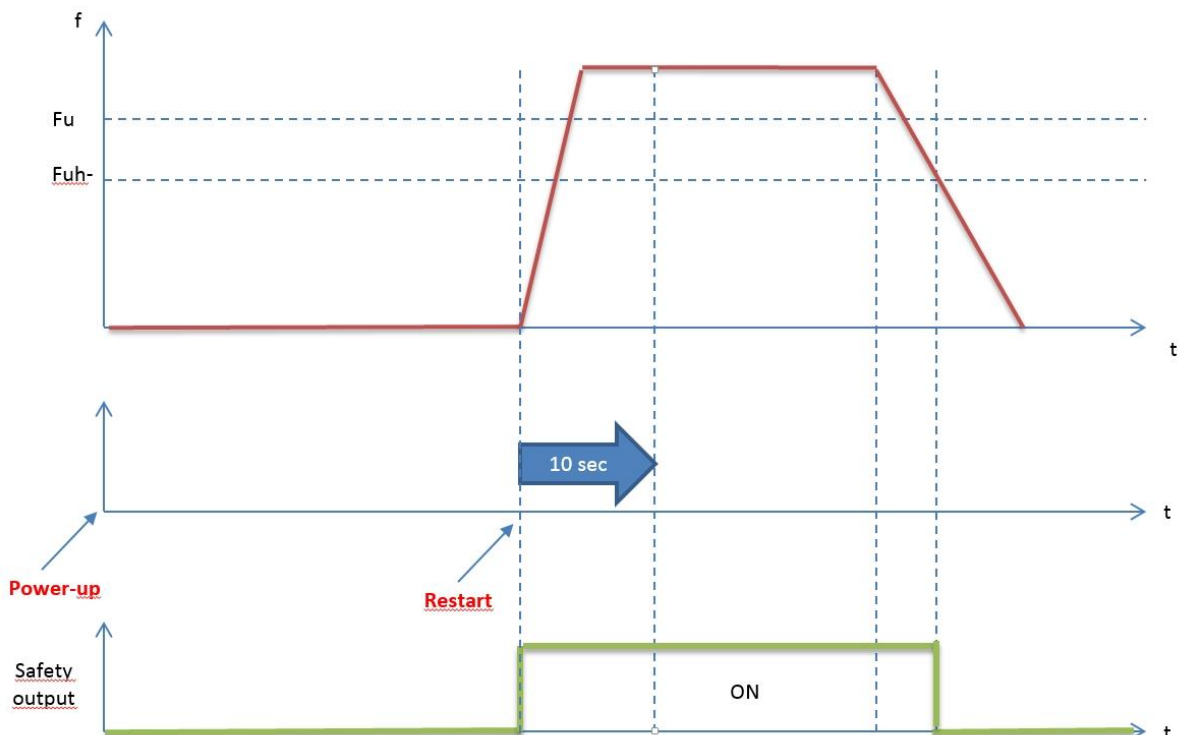

If the frequency value decreases below the F_{uh} value the current paths open.

HYSTERESIS

The hysteresis determines the distance between the switch point (open the current paths) and the switch-on point (close the current paths).

The hysteresis value is fixed at 5 %.

If the input frequency falls below the set switch point by 5 %, the relays are de-energised and the current paths are open.

Example with switch point $F_u = 1000$ (rpm):

- the current paths are closed when the input frequency is over F_u ;
- the current paths will be open when the measured value is lower than F_{uh} (in this case 950 rpm).

INITIALISATION

Directly after power on, the SV MRO U carries out an initialisation comprising a complete self-test.

After approx. 3 s the SV MRO U is ready for operation.

INSTALLATION

Mechanical installation of the device

- ▶ Mount the device on a DIN rail in a housing protected against dust and humidity (min. IP 54).



Leave enough space between the unit and the top and bottom of the housing to enable air circulation and to avoid excessive heating.



Take into account the internal heating of all units when mounting several units side by side. The environmental conditions must be observed for every unit and, in order to avoid overheating, maintain between them one minimal distance of 2cm.

- ▶ Fasten the units to the rail.
- ▶ Lock it first on the upper side of the rail.
- ▶ Pull down the locking latch on the back of the unit.
- ▶ Press the unit gently and release the latch until you feel it snap into place.

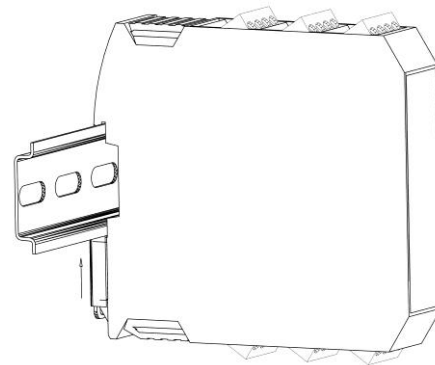
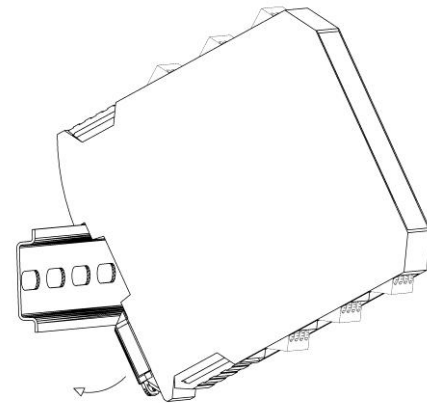

- ▶ To remove a unit, use a screwdriver to pull down the locking latch on the back of the unit; then lift the unit upwards and pull.

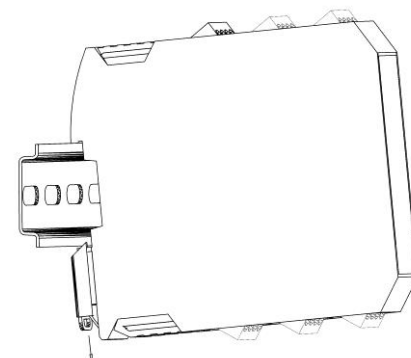

Electrical Connections

Voltage supply sensors:	+24VDC: max. 70mA, protected (by a resettable fuse at T=20 °C), short-circuit proof, not monitored. Ground: directly connected to the device ground.
Sensors:	PNP sensors, bounce-free.
Feedback circuit:	Yes - Max. 100 mA, short-circuit proof.
Enable input:	Yes - Via the enable input is possible to switch off the limit value monitoring.
Diagnostic output:	Positive switching transistor output. Max. 100mA, short-circuit proof.
Fault output:	Positive switching transistor output. Max. 100 mA, short-circuit proof.
Enable path:	2 x NO - Potential free - Max. 6A (protected with external 3.6 A).

Supply voltage



Connect the supply voltage of the device to terminals L+ and L- .
 The nominal voltage is 24VDC. This voltage may vary between 19.2 V and 28.8 V incl. 5% residual ripple.
 PELV power supplies are to be used (EN 60204-1).

TERMINALS

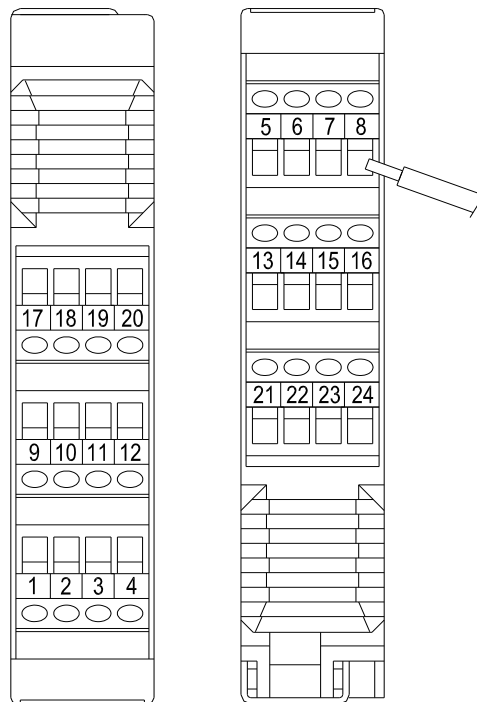

The electrical input signals meet the requirements of EN61131.



Terminal tightening torque: 5 ÷ 7lb-in (0,6 ÷ 0,7 Nm).

Terminal connection: "UPPER SIDE"		
A1	1	Operating voltage (+24VDC)
	2	Sensor1 supply (+24VDC)
	3	Sensor1 supply (GND)
	4	Sensor1 input
A2	9	Operating voltage (GND)
	10	Sensor2 supply (+24VDC)
	11	Sensor2 supply (GND)
	12	Sensor2 input
A3	17	current path 1A (relay contacts)
	18	-
	19	-
	20	current path 1B (relay contacts)
Terminal connection: "LOWER SIDE"		
C1	5	enable plus-switching
	6	enable ground-switching
	7	Automatic mode selection
	8	Manual mode selection
C2	13	transistor output "Fault" → (Fault output (13))
	14	transistor output "Underspeed"
	15	feedback circuit output
	16	feedback circuit input
C3	21	current path 2A (relay contacts)
	22	-
	23	-
	24	current path 2B (relay contacts)



The relay contacts of the module shall be supplied by the same source.

Set up of the device

After the first power on of the device it is necessary to configure the Underspeed Frequency (Fu) using the three decade switches located in front of SV MRO U.

The switches allow the user to enter the value of the desired preset frequency (as described below).

Switch point selection description

The switch point is selectable by means of 3 "decade switches" (270° potentiometer, 10 positions, locking).

- ▶ With P1 and P2 switches numerical values from 01 to 99 can be set (switch 1 with increments of 10, switch 2 with increments of 1).
- ▶ With a third switch (P3) the multiplier is set. The numerical values are multiplied with these factors and thus provide the actual switch point value. The multipliers have the unit "rpm" or Hz".













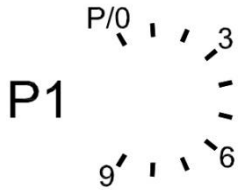



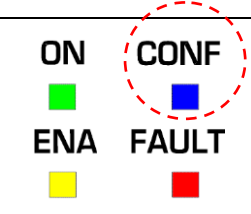



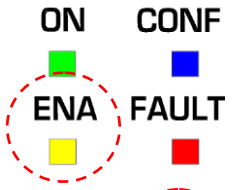



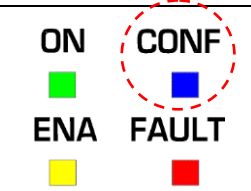
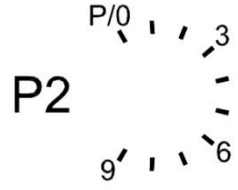



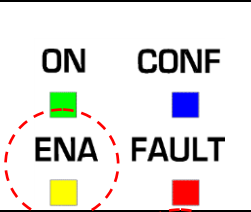

The unit *rpm* is only applicable when 1 cam/revolution is present.

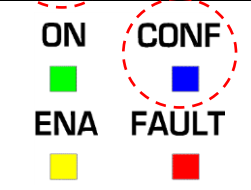
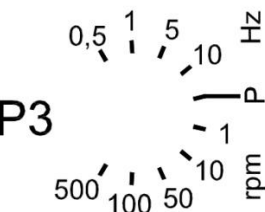

To select the desired value, at the power ON, the 3 switches must be in the "P" position.

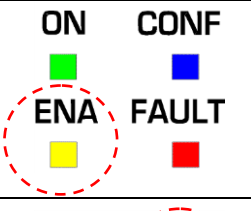

In order to not damage the potentiometers use a screwdriver of the appropriate size.

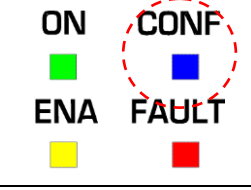
SWITCH	OPERATION / RESULT	LED
Start of configuration: ► Set the 3 switches to configuration position O/P ► Switch on the power supply of the device		
	► The LED CONF is blinking ► Adjust Potentiometer P1 from the position O/P to the needed Value	ON  CONF  ENA  FAULT  
	► During the rotation, the led ENA lapse by every Step (check with this visualization the corrected value)	ON  CONF  ENA  FAULT  
	► System resting in Configuration-Mode Waiting for input P2 ► The LED CONF is still blinking	ON  CONF  ENA  FAULT  
	► Adjust Potentiometer P2 From the position O/P to the needed Value ► During the rotation, the led ENA lapse by every Step.	ON  CONF  ENA  FAULT  
	► System resting in Configuration-Mode Waiting for Input P3 ► The led CONF is still blinking	ON  CONF  ENA  FAULT  
	► Adjust Potentiometer P3 From the position P to the needed Value ► During the rotation, the led ENA lapse by every Step ► Led CONF becomes fixed.	ON  CONF  ENA  FAULT  
	► Wait until led CONF is blinking twice (memorization) ► Turn OFF the power	ON  CONF  ENA  FAULT  
End of configuration		



All the 3 switches must be moved at least one time to select a correct value even if the selected value is "0" (correspondent to the "O/P" position).

Examples

The switch point value can only be set when operating voltage is connected to the device and the three switches are set as indicated (*factory setting*).

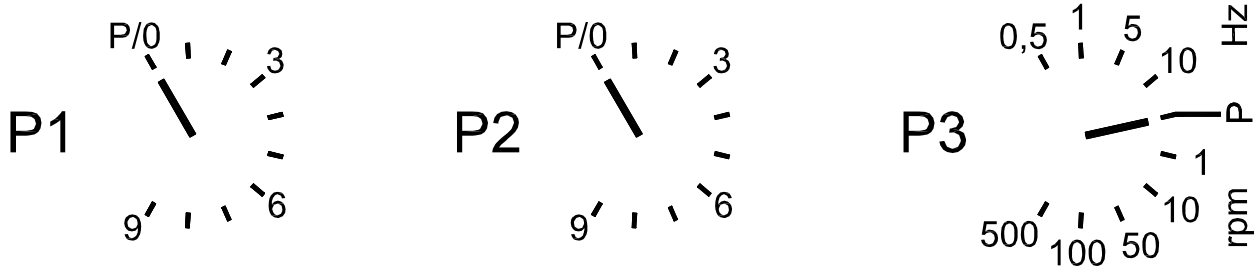

Figure 1 - Factory setting

Set P1, P2 and P3 to obtain the switch point value. Examples:

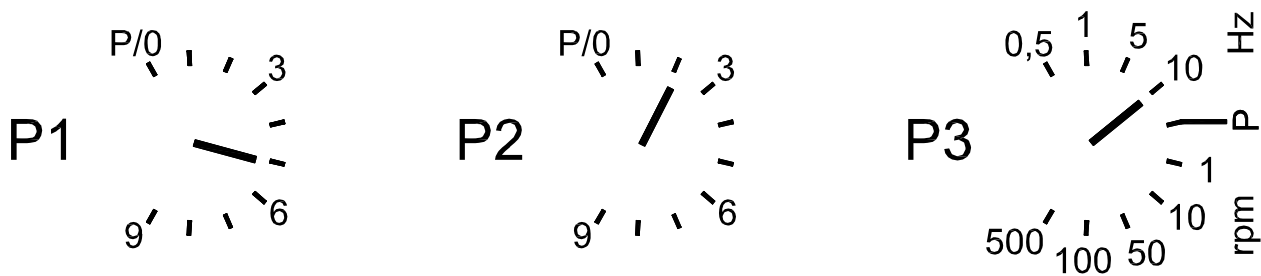

Figure 2 - Example 1: 520Hz

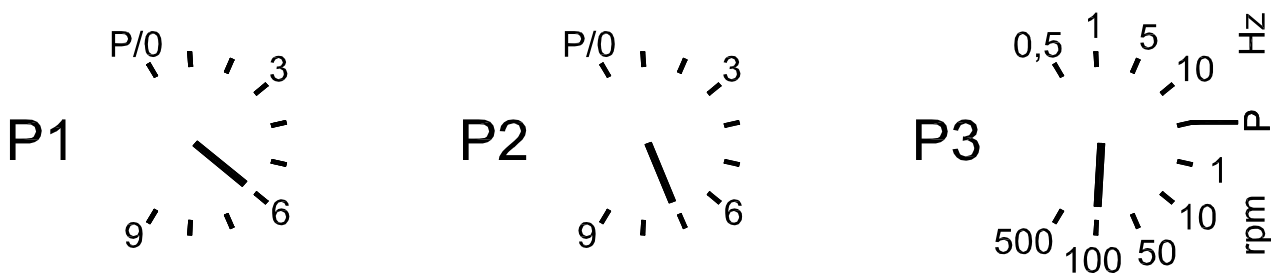

Figure 3 - Example 2: 6700rpm

AUTOMATIC/MANUAL MODE SELECTIONS

The selection of the operative mode between Automatic or Manual is made by two input terminals 4 and 5. In figures below the two possible selections are showed.

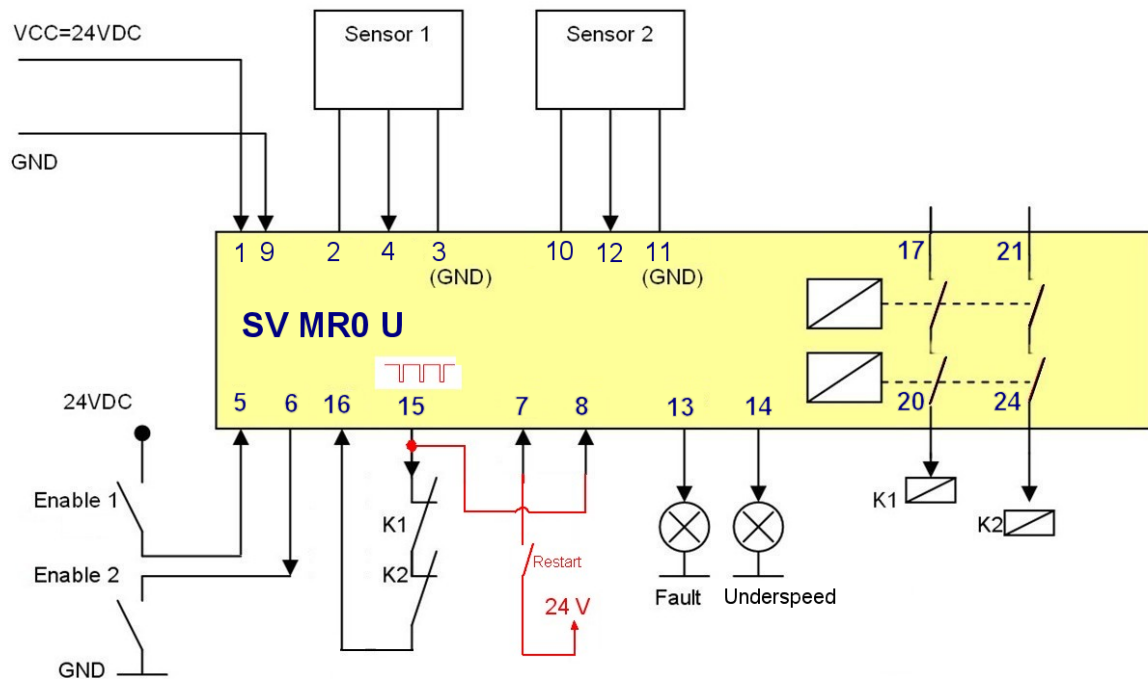

Figure 4 - Manual mode selection

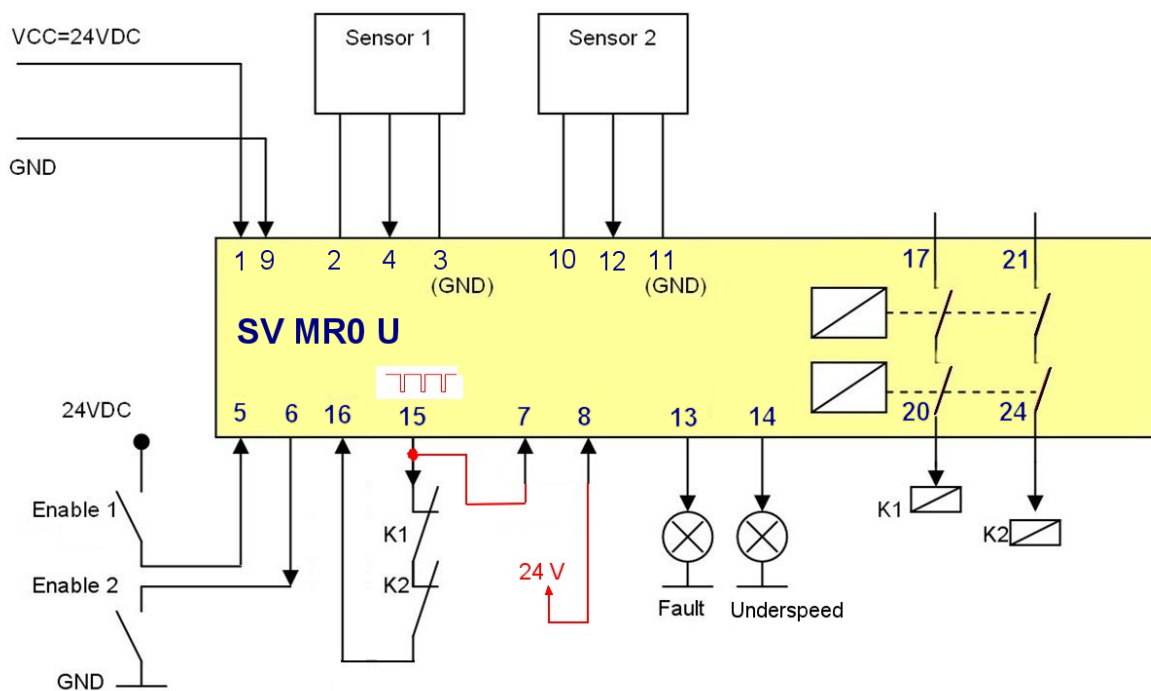

Figure 5 - Automatic mode selection

Automatic mode

With Automatic Mode selected, just after the power up, a 10 seconds timer automatically starts and during all these 10 seconds the output relays are closed. This permits to the motor connected to the relays to reach the selected frequency. If after these 10 seconds the frequency has been reached, the relays could remain closed. As soon as the input frequency goes below the selected frequency (underspeed condition) the relays are de-energised immediately.

When the input 7 is connected to 15 (pulsed output test) and the 8 input is connected to 24VDC, the Automatic mode is selected.

If a failure is detected (short circuit to 0VDC or 24VDC or that connections have been removed) the device will pass to the failsafe status.



The 10 seconds initial timer is a temporary suspension of the protective function. Carefully check your risk analysis in order to assess whether these function is compatible with your application and what additional measures have to be taken (i.e. gard lock, protective fence, etc.)



When the relay outputs are connected directly to drive a motor, verify if the Automatic mode could be used.

In some applications an uncontrolled restart could be dangerous. The module must be used only as a speed monitoring device and not to directly control the machine. Carefully check if the automatic mode could be applied.

Manual mode

With Manual Mode selected, after the power up, the output relays are de-energised and the module waits for a restart command. When a Restart command is received, a 10 seconds timer starts and during all these 10 seconds the output relays are closed. This permits to the motor connected to the relays to reach the selected frequency.

If after these 10 seconds the frequency has been reached, the relays could remain closed. As soon as the input frequency goes below the selected frequency (underspeed condition) the relays are de-energised immediately and the module waits again for a Restart command via the RESTART input (terminal 7).



This 10 seconds timer is a temporary suspension of the protective function. Carefully check your risk analysis in order to assess whether these function is compatible with your application and what additional measures have to be taken (i.e. gard lock, protective fence, etc.)

- > If it is detected during the initialisation that the input 8 is connected to 15 (pulsed output test) and 7 is open then the Manual mode is selected.
- > In this case the relay path remains open until a Restart signal in Input 7 happens. The Restart signal on input 7 will respond after the falling edge (a complete transition 0VDC >> 24VDC >> 0VDC) of this input.



The RESTART command must be installed outside the dangerous area in a position where the dangerous area and the entire work area concerned are clearly visible.



It must not be possible to reach the control from inside the dangerous area.



The duration of the Restart signal is also checked from a minimum of 300ms to a maximum of 5sec. Otherwise the command is rejected.



If the Restart command is activated (rising edge or falling edge or both) when the frequency is between F_u and F_{uh} the command is also rejected.

When the module is waiting for the restart (clear status) a yellow led (ENA) is blinking indicated this status.

See figure below for a diagram about the manual mode selections.

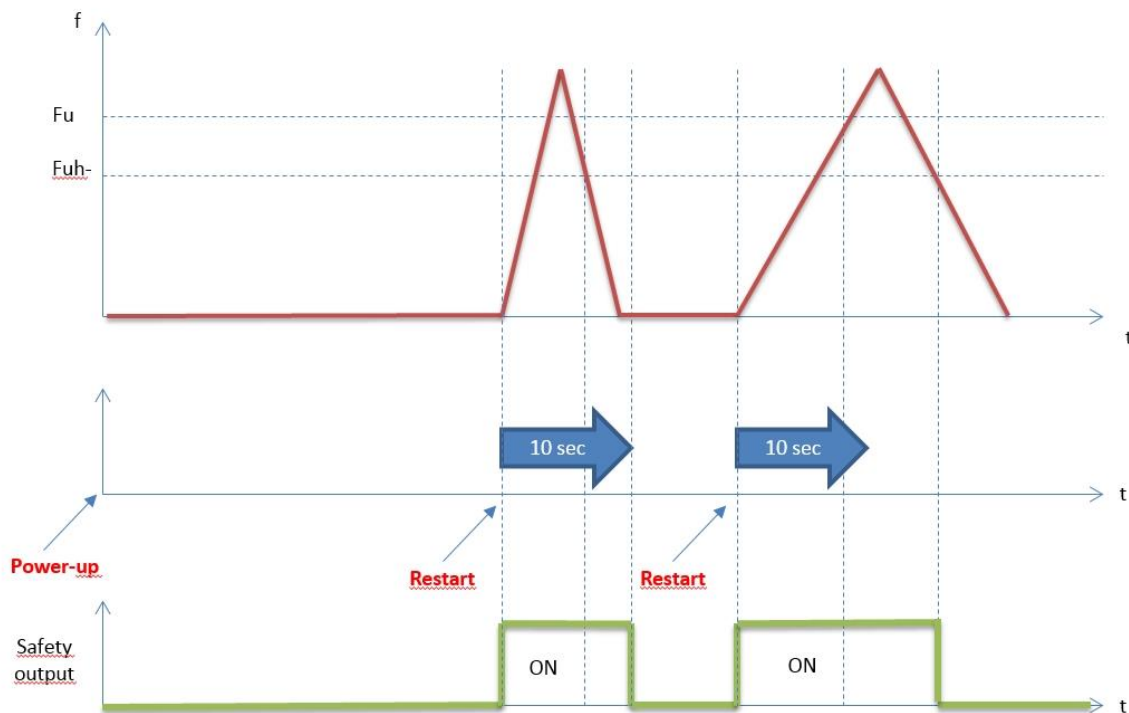

Figure 6 - Manual mode/restart diagram

ENABLE INPUT:

If several modules with different switch points are used for Underspeed monitoring of a drive, the devices whose switch point value is not relevant can be "switched off" by means of the **enable** input pairs.

The current paths are then closed. In this way the relay status can be controlled via the **enable** input after power on of the device.

Activation or deactivation is done by means of an antivalent signal to both **enable** inputs.

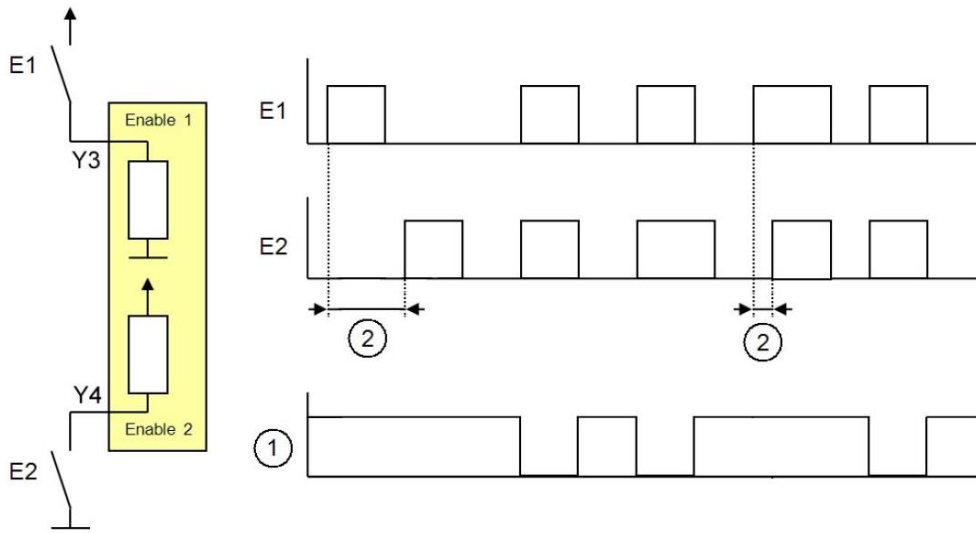

Figure 7 - Enable timing

Enable inputs E1 and E2:

- 1: The monitoring function of the device is active/not active
- 2: Enable signals not simultaneous

The signal can be applied via mechanical switches.

In Figure 7 a signal curve is showed.



A maximum of 0.5s of simultaneity between the two input E1 and E2 a is allowed.

TECHNICAL DATA SV MRO U

Voltage supply		
Supply voltage U_v	24VDC	
Voltage range	80 ... 120 %	
Power consumption	< 3 W	
Device response time (ms)		
$(f_{sel} \geq 100\text{Hz})$	$T_r = 10,7 + 400 \cdot (f_{sel}/f_{in})$	$f_{sel} = \text{selected frequency (by potentiometers)}$
$(f_{sel} < 100\text{Hz})$	$T_r = 14 + (4500/f_{in})$	$f_{in} = \text{input frequency (from proximities)}$
Inputs		
Voltage	24VDC	
Current	typ. 6mA / 24VDC (for HIGH level)	
Max. input frequency	2,000 Hz Min Pulse Width for frequency > 500Hz: 100µs. Min Pulse Width for frequency ≤ 500Hz: 150µs.	
Setting range of the limit speed	0.5 ... 990 Hz	
Speed ranges	10 rpm to 49,500 rpm	
Outputs		
Output function	2 safety-related switching outputs (floating contacts) 1 fault output "FAULT" (positive switching) 1 diagnostic output "UNDERSPEED" (positive switching)	
Output data	FAULT (13) and UNDERSPEED (14) ≤ 20mA / 24VDC, voltage drop, ≤ 2V short-circuit proof, not safe	
Switching function	Outputs 17-20 and 21-24 open if input frequency below switch point Transistor outputs 13 open (LOW) in case of internal/external fault Transistor outputs 14 open (LOW) when current paths are open	
Sensor outputs		
Voltage	24VDC	
Current	≤ 70 mA / 24VDC	
Voltage drop	≤ 2 V	
Diagnostic and fault outputs		
Voltage	24VDC	
Current	≤ 20mA / 24VDC	
Voltage drop	≤ 2 V	
Enabling circuits		
Switching capacity	24VDC , 250VAC / 6mA - 6A, resistive Load	
Protection housing and terminals	IP 20	
Contact protection	3.6A externally	
Max. ambient temperature	-40 .. +55 °C	
Max. storage temperature	-40 .. +70 °C	
Max. altitude (above sea level)	2000 m	
Relative humidity	10% ÷ 95%	
Connection type	terminals blocks	
Housing		
Housing	108 x 22.5 x 114.5	
Standards		
EN ISO 13849 / EN 61508	PL e / Cat. 4; SIL 3;	
RoHS	conform	

TECHNICAL DATA CONCERNING SAFETY*	PFHd (IEC 61508)	HFT (IEC 61508)	MTTFd (EN ISO 13849-1)	DCavg (EN ISO 13849-1)
DC13 (2A)@24Vdc	7,69E-09	1 type B	528,73	99,0%
AC15 (1A) @220Vac	8,25E-09	1 type B	496,36	99,0%
AC15 (3A)@220Vac	9,15E-09	1 type B	451,54	99,0%
Device lifetime	20 years			
Safe state	Output relay open			
Failure response time	5,5 ms			

* Considering 1000 relay operations/year

DEFINITION OF THE LED'S

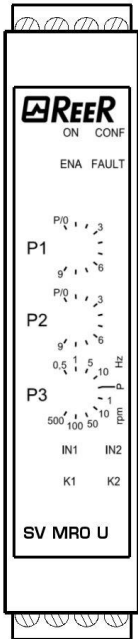

LED		COLOUR
IN2	Input IN2	yellow
IN1	Input IN1	Yellow
K2	Indicator Relay K2	Green
K1	Indicator Relay K1	Green
ENA	Indicator Enable	Yellow
CONF	Indicator Configuration	Blue
ON	Power Indicator	Green
FAULT	Fault Indicator	Red

IN2	Input Sensor IN2 lights, when a high signal at the input IN2 was detected.
IN1	Input Sensor IN1 lights, when a high signal at the input IN1 was detected.
K2	Indicator Relay K2 lights when the safety output relay K2 is switched on.
K1	Indicator Relay K1 lights, when the safety output relay K1 is switched on.
ENA	Indicator Enable lights when the Enable inputs are logical on. In configuration mode this LED blinks rotating the potentiometers (one blink for each step). In clear status (waiting for a restart command) this led blinks. → (Manual Mode)
CONF	ON when device in configuration mode Blinking when switches are in P position.
ON	Indicator ON lights, when the safety module is powered.
FAULT	Indicator Fault lights when an internal fault is detected. Indicator Fault is flashing, when an external fault (i.e. the sensor-test) is detected. → (Faults (Blinkings))

FAULTS (BLINKINGS)

Number of blinkings	Fault
1	MANUAL/AUTOMATIC configuration error
2	Switches incorrect position (frequency selectors)
3	EDM error (With IN1/IN2 flashing simultaneously: IN1 or IN2 absent.)
4	Proximity error
5	Overload outputs 2 (sensor1 supply) or 10 (sensor2 supply) or 13 (fault) or 14 (Underspeed) or 15 (FBK circuit).

Additional notes

PULSE INPUTS, PULSE PICK-UPS

- ➔ The input signals from proximity must be bounce-free.

SWITCHING OUTPUTS:

- ➔ The NO contacts of the internal relays are connected "in series" so that the current paths are not closed before both relays have switched.

RESTART COMMAND:

- ➔ The duration of the Restart signal is checked from a minimum of 300ms to a maximum of 5sec. Otherwise the command is rejected.

FAULT OUTPUT:

- ➔ The transistor output "Fault" (13) opens when an internal or external error occurs. Output characteristics: max. 100mA, short-circuit proof, non-safe.

UNDERSPEED OUTPUT:

- ➔ The Underspeed output (14) is "HIGH" when the current paths are closed and "LOW" when the current paths are opened.
Output characteristics: max. 100mA, short-circuit proof, non-safe.

FEEDBACK CIRCUIT:

- ➔ When Underspeed is detected the current paths open and the external relays are de-energised. If the feedback circuit (series on external contactor NC contacts) does not close within 1s there will be an error message (FAULT led lighted on and K1, K2 led blinking).
- ➔ If the feedback function is not required, the terminals (15-16) can be permanently bridged.

Checklist after installation

- ➔ Directly after power on, the SV MRO U carries out an initialisation comprising a complete self-test. Anyway to have the system perfect operation perform the following checks at start up and at least every one year:

1. *Verify that all the cables are correctly inserted and the terminal blocks well screwed.*
2. *Verify that all the leds (indicators) light on correctly.*
3. *Verify the positioning of all the sensors connected to SV MRO U.*
4. *Verify the correct fixing of SV MRO U to the Omega rail.*
5. *Verify that all the external indicators (lamps) work properly.*
6. *Verify that the potentiometers works correctly.*

Warranty

ReeR warrants that each SV MRO U unit in new ex-factory condition, in conditions of normal use, is free of defects in the materials and of manufacturing defects for a period of 12 (twelve) months.

In this period, ReeR undertakes to eliminate any faults in the product through repair or replacement of the faulty parts, completely free of charge as regards material and labor. However, ReeR reserves the right to replace the entire faulty appliance with another equivalent appliance or with the same characteristics instead of repairing this.

Validity of this warranty is regulated by the following conditions:

- The user must inform ReeR of the fault within twelve months from the date of delivery of the product.
- The appliance and its components must be in the conditions in which they were delivered by ReeR.
- The serial numbers must be clearly legible.
- The fault or defect has not been caused directly or indirectly by:
 - Improper use;
 - Non-compliance with instructions for use;
 - Carelessness, inexperience, incorrect maintenance;
 - Repairs, modifications, adaptations not carried out by ReeR personnel, tampering, etc.;
 - Accidents or impacts (also due to transportation or causes of force majeure);
 - Other causes not to be ascribed to ReeR.

Repairs will be carried out at the ReeR laboratories to which the material must be delivered or dispatched: transport risks and the risks of any damage or loss of the material during shipment are the responsibility of the user.

All products and components replaced become the property of ReeR.

ReeR does not recognize any other warranties or rights except for those specifically described above; therefore, no claims for damages may be submitted for expenses, interruption of business or other factors or circumstances in any way related to failure of the product or of one of its parts.

*Precise, complete compliance with all the rules, instructions and prohibitions indicated in this handbook is an essential requirement for correct functioning of the safety interface.
REER s.p.a. therefore declines any responsibility for all and anything resulting from failure to comply, even partially, with such indications..*

Characteristics subject to change without notice. • Total or partial reproduction is forbidden without the prior authorization of REER.



Via Carcano, 32
10153 Torino, Italy
T +39 011 248 2215
F +39 011 859 867
www.reersafety.com
info@reer.it

